

vtech®

CareLine™

Abridged user's manual

www.vtechphones.com



Models:
SN1196/SN1197/SN6196/
SN6196-2/SN6197/SN6197-2



DECT 6.0

This **Abridged user's manual** provides you with basic installation and operation instructions. A limited set of features are described in abbreviated form.

Please refer to the online **Complete user's manual** for a full set of installation and operation instructions at **www.vtechphones.com**.

Before using the VTech product, please read **Important safety instructions** on pages 73-74 of this manual.



The ENERGY STAR[®] program (www.energystar.gov) recognizes and encourages the use of products that save energy and help protect our environment. We are proud to mark this product with the ENERGY STAR[®] label indicating it meets the latest energy efficiency guidelines.



Telephones identified with this logo have reduced noise and interference when used with most T-coil equipped hearing aids and cochlear implants. The TIA-1083 Compliant Logo is a trademark of the Telecommunications Industry Association. Used under license.

Register online to get an additional 3-month warranty!
Visit www.vtechphones.com.



Registration

Register your product online for enhanced warranty support.



Product news

Learn about the latest VTech products.

Parts checklist

Your telephone package contains the following items. Save your sales receipt and original packaging in case it is necessary to ship your telephone for warranty service.

SN1196/SN1197

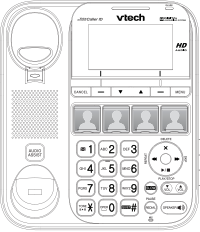

Telephone base



Corded handset



Pendant with lanyard



Pendant charger with
charger adapter



Pendant belt clip

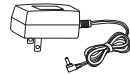

Telephone base power adapter



Telephone line cord

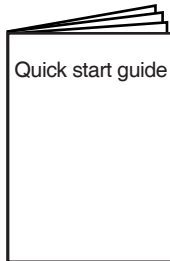

Quick start guide

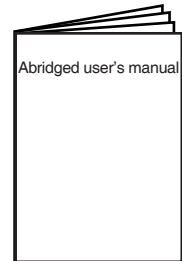

Abridged user's manual

Parts checklist

SN6196/SN6196-2/SN6197/SN6197-2

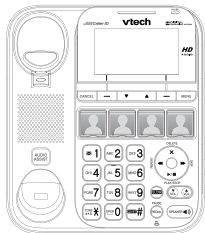

Telephone base



Corded handset



Pendant with lanyard



Cordless handset
(1 for SN6196/SN6197)
(2 for SN6196-2/SN6197-2)

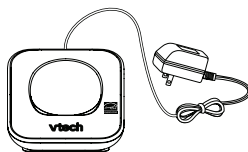

Handset charger with
charger adapter
(1 for SN6196/SN6197)
(2 for SN6196-2/SN6197-2)



Pendant charger with
charger adapter



Battery compartment cover
(1 for SN6196/SN6197)
(2 for SN6196-2/SN6197-2)



Battery
(1 for SN6196/SN6197)
(2 for SN6196-2/SN6197-2)



Pendant belt clip

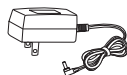

Telephone base
power adapter



Telephone
line cord

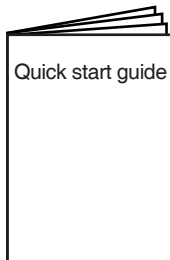

Quick start guide

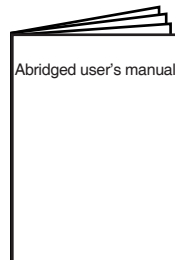

Abridged user's manual

Table of contents

Getting started	1	Key tone	25
Telephone base installation.....	1	Use caller ID to automatically set date and time	25
Handset battery installation	2	Home area code	26
Handset charger installation	3	Dial mode	26
Pendant charger installation.....	4	Quiet mode	27
Pendant attachment	5	Happy message.....	27
Telephone base backup battery installation	6	Voice command.....	28
Handset battery charging	7	Telephone operation	29
Pendant battery charging	7	Make, answer and end a call....	29
Are you a new cable or VoIP subscriber?	8	Speakerphone	30
Did you subscribe to voicemail service from your telephone service provider?.....	8	Equalizer.....	30
Expand your telephone system ..	9	Audio Assist®	30
Add and register a handset	9	Volume control.....	31
Add and register a pendant	10	Mute.....	31
Deregister all devices	11	Call waiting	31
Telephone base layout	12	Temporary ringer silencing	32
Pendant layout.....	15	Redial	32
Handset layout.....	16	Temporary tone dialing.....	32
Telephone settings	18	Check voicemail	33
Photo speed dial.....	18	Chain dialing.....	33
Using the menu	20	Transfer a call.....	34
Ringer volume	20	Find handset/pendant.....	35
Ringer tone	21	Multiple handset use	36
Set date and time	22	Join a call in progress.....	36
Voice Announce® caller ID.....	22	Intercom.....	37
LCD language.....	23	Phonebook	39
Talking digit	23	Add a phonebook entry	39
Voicemail number.....	23	Review phonebook entries	39
Clear voicemail indicators.....	24	Alphabetical search	39
Rename base/handset	24	Dial a phonebook entry.....	40
		Edit a phonebook entry.....	40
		Delete a phonebook entry	40

Table of contents

Photo speed dial	41	Using the answering system and voicemail together.....	53
Store a photo speed dial entry...	41	Message capacity.....	53
Edit a photo speed dial entry ...	41	Call screening.....	54
Delete a photo speed dial entry ...	41	Call intercept.....	54
Dial a photo speed dial number ...	42	Temporarily turn off the message alert tone	54
Caller ID	43	Message playback.....	55
Missed call indicator	43	Delete all old messages	57
Review the caller ID log.....	43	Record, play and delete memos	57
View dialing options.....	44	Remote access.....	58
Save a caller ID log entry to the phonebook	44	Voice command	59
Reminder	45	About voice command.....	59
About the reminder	45	Use voice command.....	59
Add a reminder	45	Appendix	61
Review reminders.....	46	Handset battery	61
Add and review reminders remotely	46	Pendant battery	62
Answering system settings	47	Troubleshooting.....	63
Answering system	47	Important safety instructions.....	73
Announcement	47	Precautions for users of implanted cardiac pacemakers	75
Record your own announcement	47	Operating range.....	75
Answer on/off.....	48	ECO mode.....	75
Call screening.....	48	Energy-saving charging mode... ..	76
Number of rings.....	49	Maintenance	76
Remote access code	50	About cordless telephones	77
Message alert tone	50	The RBRC® seal	78
Message recording time	51	Limited warranty	79
Answering system operation	52	FCC, ACTA and IC regulations ...	81
Answering system and voicemail	52	Technical specifications.....	84
		Index	85

Getting started

Telephone base installation

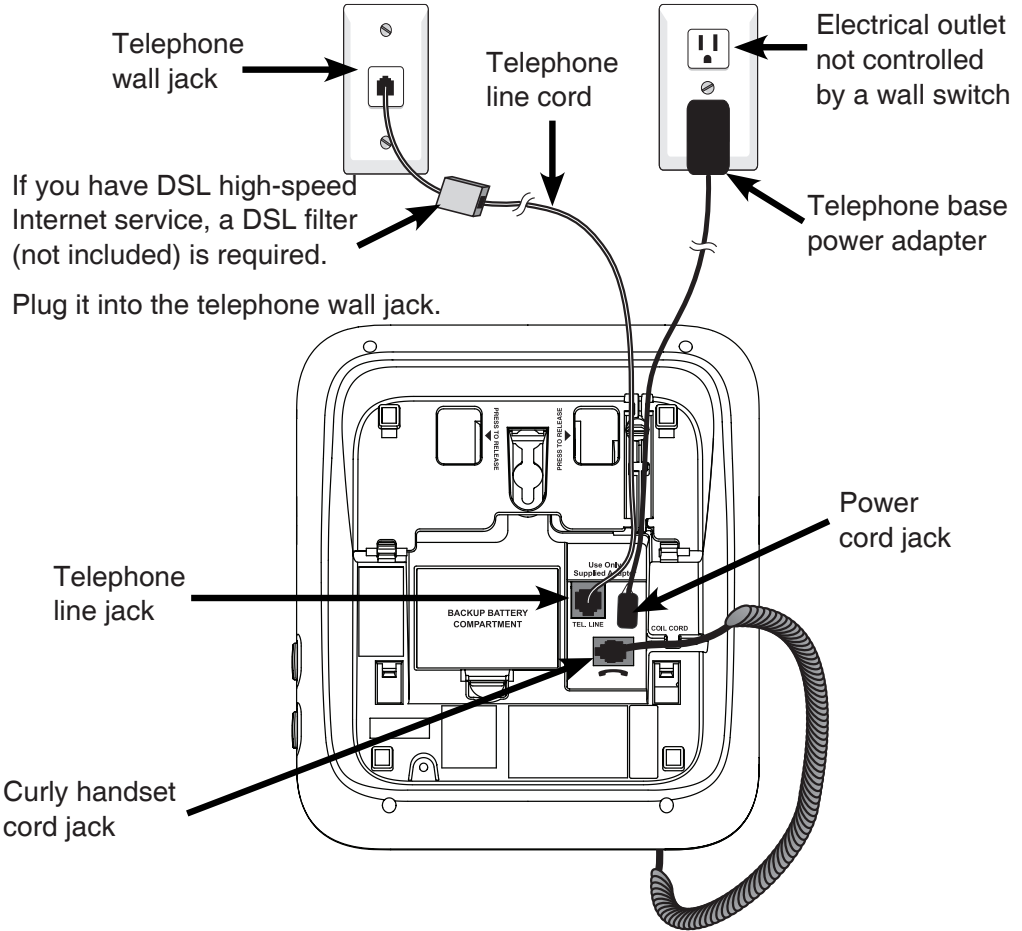

CAUTION:

If you subscribe to telephone service from a cable company or a VoIP service provider, contact your cable/VoIP service provider for more information.

Getting started

Handset battery installation

1. Plug the battery connector securely into the socket.

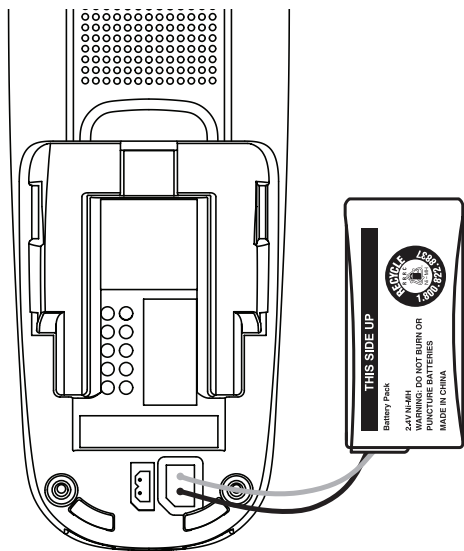

2. Place the battery with the label **THIS SIDE UP** facing up and the wires inside the battery compartment.



3. Slide the battery compartment cover towards the center of the handset until it clicks into place.

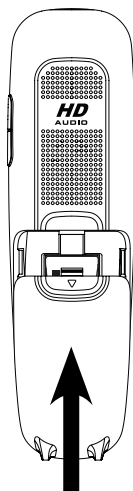

Getting started

Handset charger installation

1. Install the charger as below.

Electrical outlet
not controlled
by a wall switch

Handset charger
power adapter

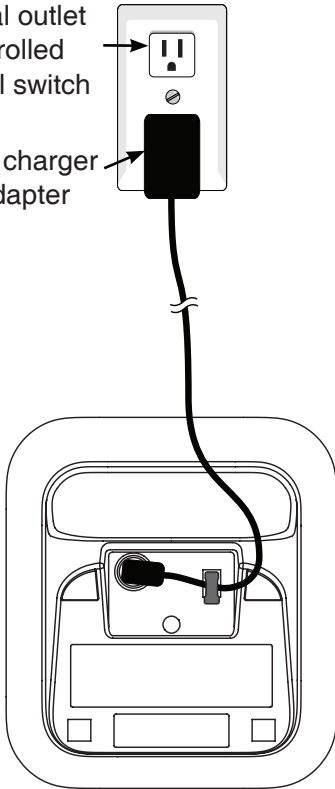

2. Place the handset in the handset charger to charge.

Stays red when
put in charger.

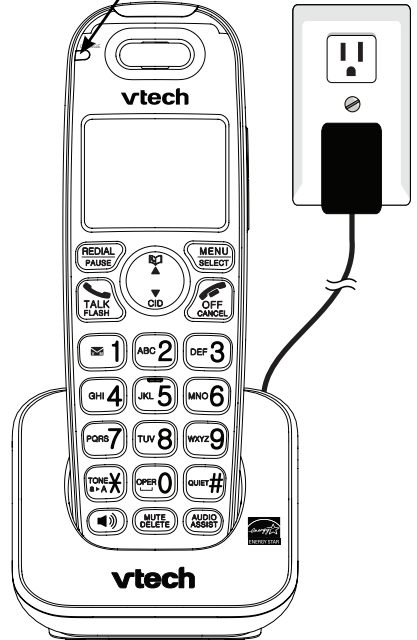

IMPORTANT:

Check for a dial tone by pressing . If you hear a dial tone, the installation is successful.

If you do not hear a dial tone:

- Make sure the installation procedures described above are properly done.
- It may be a wiring problem. If you have changed your telephone service to digital service from a cable company or a VoIP service provider, the telephone line may need to be rewired to allow all existing telephone jacks to work. Contact your cable/VoIP service provider for more information.

Getting started

Pendant charger installation

1. Install the pendant charger as shown below.

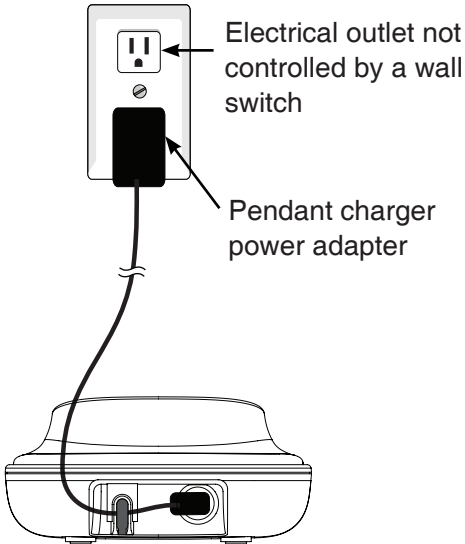

2. Switch **ON** the pendant.

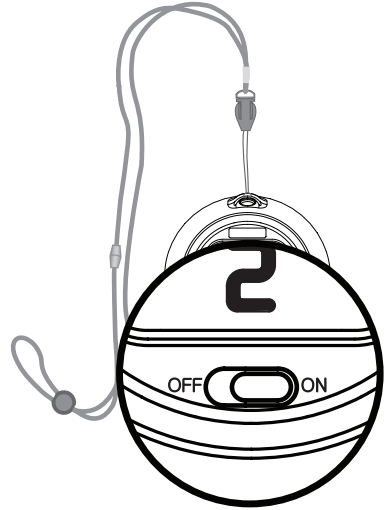

3. Place the pendant in the pendant charger to charge.

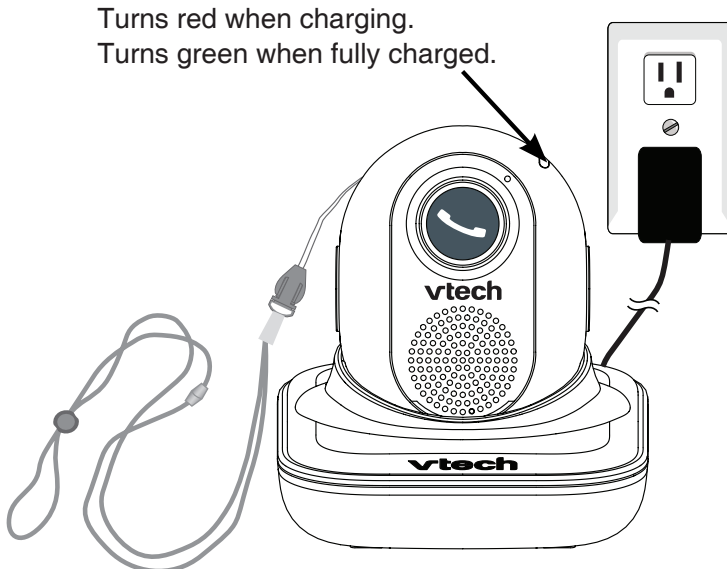

Getting started

Pendant attachment

Pendant lanyard:

The pendant lanyard is already attached to the pendant. You can adjust the length of the lanyard for comfortable wearing, or remove the necklace when necessary.

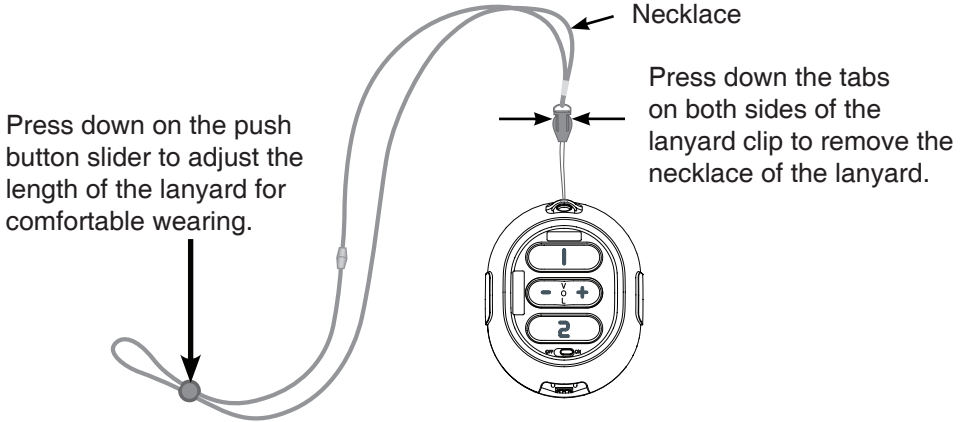

Pendant belt clip:

Remove the necklace of the pendant lanyard or the whole pendant lanyard before you use the pendant belt clip.

Push the pendant into the belt clip until it clicks into place



Getting started

Telephone base backup battery installation

Install three AAA batteries (not provided) so that your telephone can still operate in the event of a power failure.

1. Press the large tab on the backup battery compartment cover. Then pull to open.

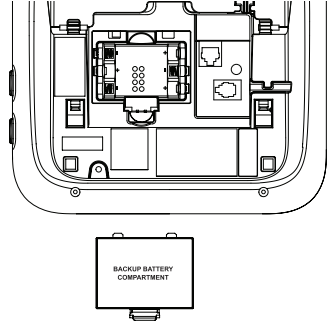
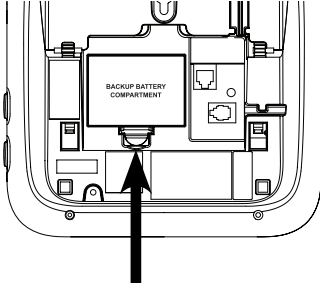

2. Place three AAA batteries into the compartment, matching the polarity engravings.

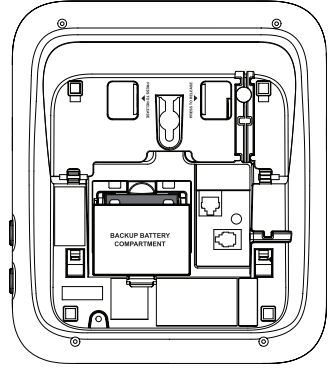
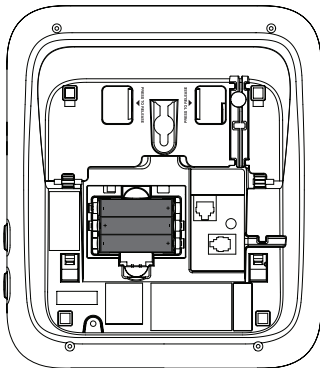

3. Replace the backup battery compartment cover. Push the large tab until it locks securely.



Getting started

Handset battery charging

Once you have installed the battery, the handset indicates the battery status. If necessary, place the handset in the handset charger to charge. The battery is fully charged after 11 hours of continuous charging.

Battery indicators	Battery status	Action
The screen is blank, or displays Place in charger and  flashes.	The battery has no or very little charge. The handset cannot be used.	Charge without interruption (about 30 minutes).
The screen displays Low battery and  flashes.	The battery has enough charge to be used for a short time.	Charge without interruption (about 30 minutes).
The screen displays HANDSET X .	The battery is charged.	To keep the battery charged, place it in the handset charger when not in use.

Pendant battery charging

The pendant status light indicates the battery status. If necessary, place the pendant in the pendant charger to charge. The battery is fully charged after 3 hours of continuous charging.

Battery indicators	Battery status	Action
The pendant status light flashes red. You hear “ <i>Low battery</i> ” when there is only 30 minutes talk time left. You hear an alert tone every one minute.	The battery has very little charge.	Charge without interruption.
The pendant status light is solid red.	The battery has enough charge to be used for a short time.	Charge without interruption.

Getting started

Are you a new cable or VoIP subscriber?

If your answer is yes, the existing telephone jacks in your home may no longer work. Your cable/VoIP service provider uses a different connection, separate from your old traditional telephone service, to connect the modem/router/terminal adapter installed in your home.

To allow all existing telephone jacks to work, contact your telephone service provider for solutions, such as rewiring services (fees may apply).

If your answer is no, your existing telephone jacks will continue to work as normal.

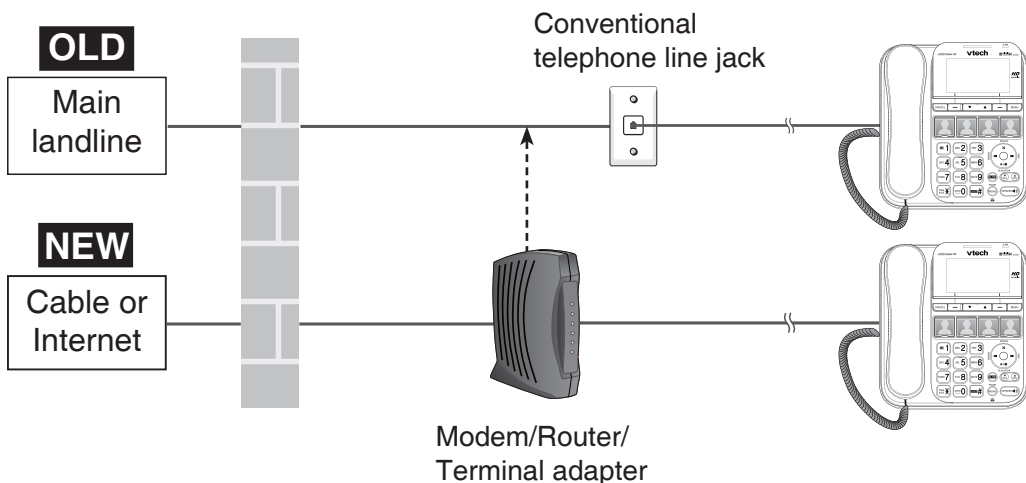

Did you subscribe to voicemail service from your telephone service provider?

Your telephone has a built-in answering system and supports voicemail feature offered by your telephone service provider (subscription is required, and fees may apply). Refer to **Answering system and voicemail** on page 52 for more information.

To use the built-in answering system:

Refer to this **Abridged user's manual** on how to record your outgoing announcement, retrieve messages and other related operations. You may also view the online **Complete user's manual** at www.vtechphones.com for complete instructions.

To use the voicemail:

To retrieve your voicemail messages, you typically dial an access number provided by your telephone service provider, and then enter a security code. Contact your telephone service provider for instructions on how to configure the voicemail settings and listen to messages.

Getting started

Expand your telephone system

Your telephone base can support up to 12 handsets/pendants. Each device must be registered to the telephone base before use.

You can add new handsets (**SN6107**, purchased separately) and new pendants (**SN6166/SN6167**, purchased separately) to your telephone base. Additional handsets are assigned numbers in the sequential order.

Add and register a handset

When first purchased, each expansion handset shows **To register HS, see manual**. The new handset should be charged without interruption for at least 30 minutes before registering it to the telephone base.

Make sure the handset is out of the handset charger and is put near the telephone base. Make sure the handset shows **To register HS, see manual** before you begin registration.

To register a handset:

1. Press **MENU** on the telephone base when idle.
2. Scroll to **Settings**, then press **SELECT**.
3. Scroll to **Registration**, then press **SELECT**.
The telephone base shows **Registering... Please wait**.
4. Press **QUIET#** on the cordless handset. The handset shows **Registering... Please wait**. Then **HANDSET Registered** appears on the cordless handset and the telephone base, and both devices beep. The handset is now registered with the telephone base. It takes up to 60 seconds to complete registration.

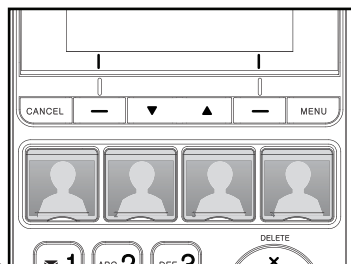

If registration fails, the telephone base displays **Registration failed**. Start again from Step 1 above.

Getting started

Add and register a pendant

When first purchased, charge the pendant in the pendant charger. You hear three beeps every 10 seconds when the pendant is not registered. The new pendant should be charged without interruption for at least 30 minutes before registering it to the telephone base.

Make sure the pendant is out of the pendant charger and turned on.

To register a pendant:

1. Press **MENU** on the telephone base when idle.
2. Scroll to **Settings**, then press **SELECT**.
3. Scroll to **Registration**, then press **SELECT**. The telephone base shows **Registering... Please wait**.
4. Put the pendant in the pendant charger. The pendant status light flashes red and green to indicate the registration is in progress. Then **PENDANT Registered** appears on the telephone base, and both devices beep. The pendant is now registered with the telephone base. It takes up to 60 seconds to complete registration.
5. If you have already set the photo speed dial keys **1** and **2**, the telephone base displays **Copied Photo Speed Dial 1 to Pendant memory 1**. Press **NEXT**, then the telephone base displays **Copied Photo Speed Dial 2 to Pendant memory 2**. Then press **OK**.

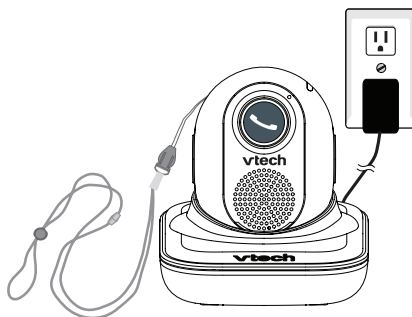
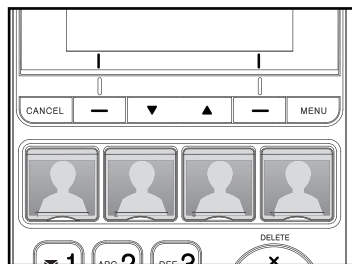

-OR-

If you have not set the photo speed dial keys **1** and **2**, see **To set photo speed dial** on page 18 to set them.

If registration fails, the telephone base displays **Registration failed**. Start again from Step 1 above.

Getting started

Deregister all devices

If you want to replace a device, or reassign the designated handset number of a registered handset, you must deregister all devices that are registered to the telephone base. Then register each device individually.

To make deregistration easier, read all of the instructions on this page before you begin.

To deregister all devices:

1. Press and hold **FIND HS** at the side of the telephone base for about 10 seconds until the telephone base shows **Registering... Please wait** followed by **Deregister all devices?**, then release **FIND HS**.

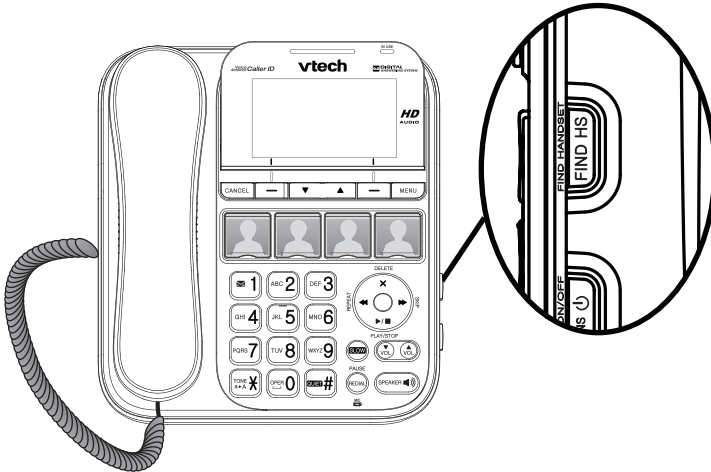

2. Immediately press **YES** or **FIND HS**.
3. All handsets show **To register HS, see manual**. The deregistration process takes about 10 seconds to complete.

To register the handset(s) or pendant(s) to the telephone base again, follow the registration instructions on pages 9-10.

note

You cannot deregister all devices if any system device is in use.

Getting started

Telephone base layout

Large tilt display

- Move the top of the display forward or backward to adjust the angle of the screen for maximum visibility.

Incoming call light

- Flashes when there is an incoming call.

IN USE light

- On when the phone is in use or the answering system is answering an incoming call.
- On when a device is being registered.
- Flashes when devices are being deregistered.
- Flashes when another telephone on the same line is in use.

Softkeys (2)

- Press to select a menu item displayed above the key.

MENU

- Press to show the menu.

Photo speed dial keys (1-4)

- Press to set or dial a speed dial number when idle.

Dialing keys

- Press to enter numbers or characters.
- Press to answer an incoming call with the speakerphone.

SPEAKER

- Press to make, answer or end a call.
- Press to switch between the corded handset and the base speakerphone during a call.

1

- While reviewing a caller ID log entry, press repeatedly to add or remove 1 in front of the telephone number before dialing or saving it in the phonebook.
- Press and hold to set or dial your voicemail number.

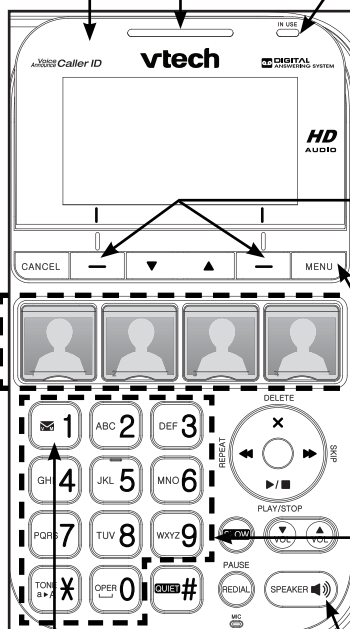

Getting started

Telephone base layout

AUDIO ASSIST

- Press to enhance the clarity and loudness of the caller's voice during a call.

CANCEL

- Press to cancel an operation, or back to the previous menu while in a menu.
- Press and hold to return to idle mode while in a menu.
- Press and hold to erase the missed call indicator when idle.
- Press to silence the base ringer temporarily while the phone is ringing.



- Press to scroll up while in menus or lists.
- Press to move the cursor to the right while entering or modifying names/numbers.



- Press to scroll down while in menus or lists.
- Press to move the cursor to the left while entering or modifying names or numbers.

REDIAL/PAUSE

- Press repeatedly to view the last 10 numbers dialed.
- Press and hold to insert a dialing pause while dialing or entering numbers.

MIC

- Microphone.

QUIET#

- Press and hold to set and turn on the quiet mode, or turn it off.
- Press repeatedly to display other dialing options when reviewing a caller ID log entry.

tone a > A

- Press to switch to tone dialing during a call if you have pulse service.
- Press to switch between upper case and lower case while entering characters.

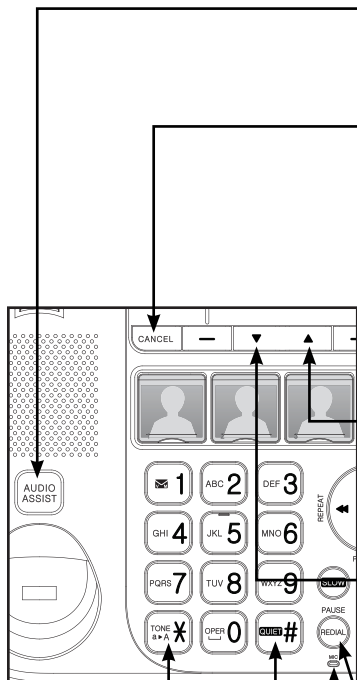

Getting started

Telephone base layout

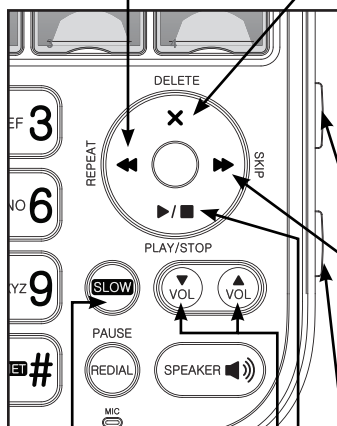

◀/REPEAT

- Press once to repeat the playing message.
- Press twice to play the previous message.
- Press to move the cursor to the left while entering or modifying names or numbers.

X/DELETE

- Press to delete the playing message/announcement/reminder.
- Press to delete an individual entry while reviewing the redial list/phonebook/caller ID log/reminder.
- Press to delete a character or digit while entering names or numbers.

FIND HS

- Press to page all handsets and pendants when idle.

▶/SKIP

- Press to skip to the next message during message playback.
- Press to move the cursor to the right while entering or modifying names or numbers.

ANS ⏻

- Press to turn the built-in answering system on/off.
- On when the answering system is turned on.

▶/■/PLAY/STOP

- Press to start or stop message playback.
- Flashes when there are new messages/memos in the answering system.

▼VOL and ▲VOL

- Press to adjust the listening volume during a call or message playback.
- Press to adjust the base ringer volume while idle.

SLOW

- Press to slow down the message playback.

Getting started

Pendant layout

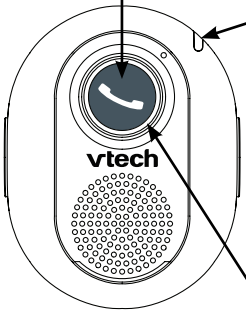

• Press to answer or end a call.

Pendant status light

- Stays solid red when the pendant is charging.
- Flashes red when the pendant is in low battery.
- Stays solid green when the pendant is fully charged.
- Flashes red and green when the base is paging the pendant.
- Flashes quickly in red and green during pendant registration.
- Flashes orange three times when the pendant is not registered.

Pendant light (ring around )

- On steady when the pendant is in use.
- Flashes quickly when there is an incoming call.
- Flashes twice every three seconds when any other telephone system device is in use.

1

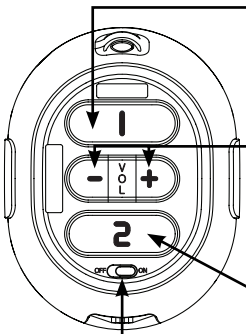

• Press to call photo speed dial 1.

VOL- and VOL+

- Press to adjust the listening volume during a call/message playback.
- Press to adjust the pendant ringer volume while in idle mode.

2

• Press to call photo speed dial 2.

ON and OFF switch

- Switch to turn the pendant on/off.

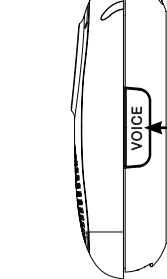

VOICE

- Press to use the voice command feature.

Getting started

Handset layout

Incoming call light

- Flashes when there is an incoming call/the base is paging the handset.



- Press to review the phonebook when idle.
- Press to scroll up while in menus or lists.
- Press to move the cursor to the right while entering names or numbers.

CHARGE light

- On when the handset is charging.

REDIAL/PAUSE

- Press repeatedly to view the last 10 numbers dialed.
- Press and hold to insert a dialing pause while dialing or entering numbers.



- Press to make or answer a call.
- Press to answer an incoming call when you receive a call waiting alert during a call.



- Press repeatedly to add or remove 1 in front of the telephone number before dialing or saving it in the phonebook while reviewing a caller ID log entry.
- Press and hold to set or dial your voicemail number.



- Press to switch to tone dialing during a call if you have pulse service.
- Press to switch between upper case and lower case while entering characters.



- Press to make or answer a call.
- Press to switch between the handset speakerphone and the handset earpiece during a call.

AUDIO ASSIST

- Press to enhance the clarity and loudness of the caller's voice during a call.

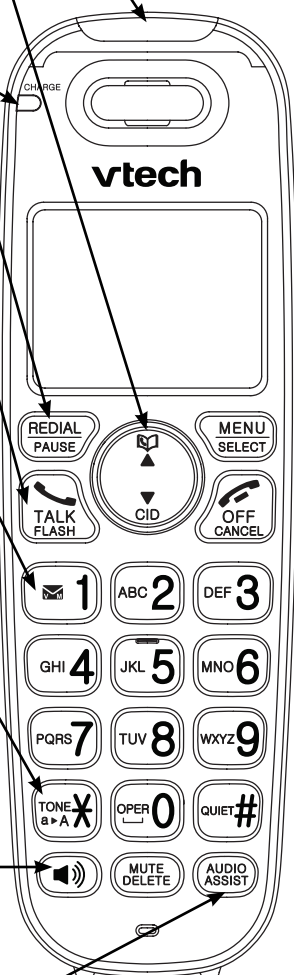

Getting started

Handset layout

CID/▼

- Press to review the caller ID log when idle.
- Press to scroll down while in menus or lists.
- Press to move the cursor to the left while entering names or numbers.

MENU/SELECT

- Press to show the menu.
- Press to select an item or save an entry/setting while in a menu.

VOL+ and VOL-

- Press to adjust the listening volume during a call or message playback.
- Press to adjust the handset ringer volume while idle.

OFF/CANCEL

- Press to hang up during a call.
- Press to cancel an operation, or back up to the previous menu while in a menu.
- Press and hold to return to idle mode while in a menu.
- Press to silence the handset ringer temporarily while the phone is ringing.
- Press and hold to erase the missed call indicator when idle.

Dialing keys

- Press to enter numbers or characters.
- Press to answer an incoming call.

QUIET#

- Press repeatedly to display other dialing options when reviewing a caller ID log entry.
- Press and hold to set and turn on the quiet mode, or turn it off.

MUTE/DELETE

- Press to mute the microphone during a call.
- Press to silence the handset ringer temporarily while the phone is ringing.
- Press to delete an individual entry while reviewing the redial list/phonebook/caller ID log/reminder.
- Press to delete a character or digit while entering names or numbers.
- Press to delete the playing message/announcement.

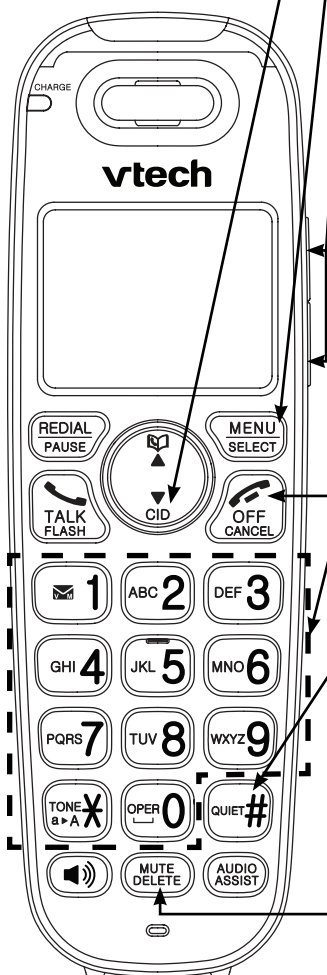

Telephone settings

Photo speed dial

There are four photo speed dial keys on the telephone base. The photo speed dial keys **1** and **2** on the pendant correspond to the photo speed dial keys **1** and **2** on the telephone base respectively.

We recommend you store two contacts that you may need to call them more often or immediately to photo speed keys **1** and **2**.

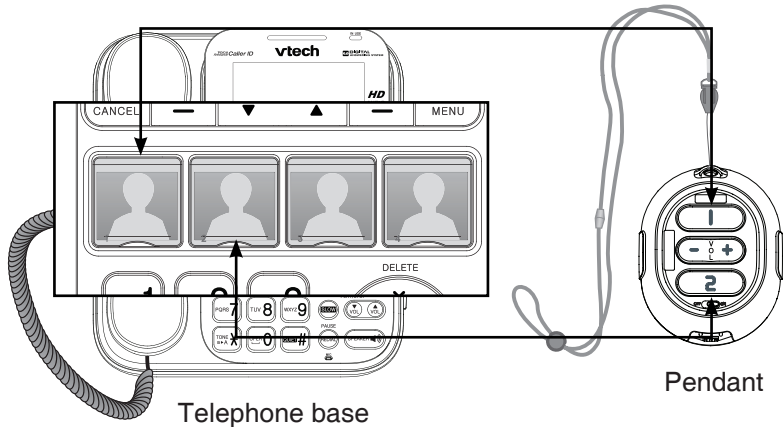

To set photo speed dial (only applicable to models with a pendant):

If your product package includes a pendant, the telephone prompts you to set photo speed dial **1** and photo speed dial **2** when it is initially powered up.

1. When the telephone base displays **Set Photo Speed Dial 1 and Pendant Memory 1**, press **YES**.
2. Enter the number, then press **NEXT**.
3. Enter the name, then press **SAVE**.
4. Press **NEXT**.
5. When the telephone base displays **Set Photo Speed Dial 2 and Pendant Memory 2**, press **YES**.
6. Enter the number, then press **NEXT**.
7. Enter the name, then press **SAVE**.
8. Press **OK**.

```
-----|-----|-----|-----|
                Set Photo
                Speed Dial 1 and
                Pendant Memory 1
                NO      YES
```

```
-----|-----|-----|-----|
                Saved Photo
                Speed Dial 1 and
                Pendant memory 1
                NEXT
```

Telephone settings

To set and dial a photo speed dial:

1. Press on a desired photo speed dial key.
2. Enter the number, then press **NEXT**.
3. Enter the name, then press **SAVE**.
4. Press on the photo speed dial key to dial.

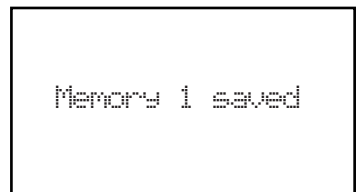
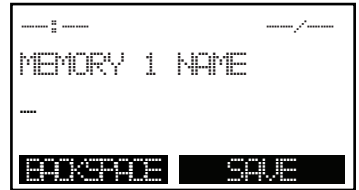
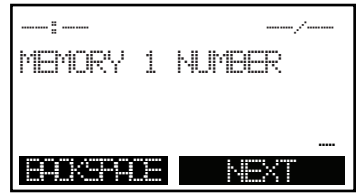

To add a photo:

You can add a desired photo into the photo speed dial compartment, or write the contact name on the photo speed dial card.

1. Flip open the photo speed dial compartment cover and take out the photo speed dial card.
2. Use the photo speed dial card as a tool to crop your desired photo.

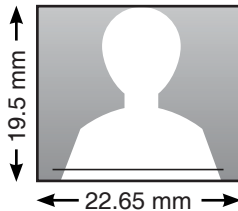

3. Put the cropped photo into the photo speed dial compartment. Then flip down the photo speed dial compartment cover.

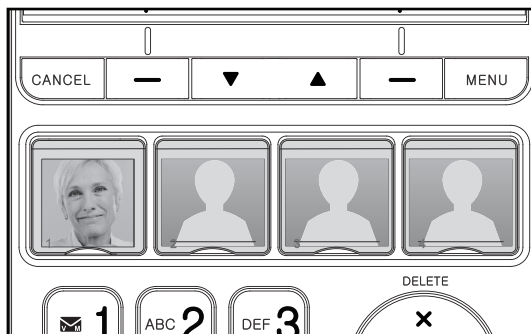

Telephone settings

Using the menu

You can use the menu of the telephone base or a cordless handset to change the telephone settings.

1. Press **MENU** when idle.
 2. Press ▼ or ▲ until the screen displays the desired feature menu.
 3. Press **SELECT** on the cordless handset/**SELECT** on the telephone base to enter that menu.
- To return to the previous menu, press **CANCEL** on the cordless handset/**CANCEL** or **BACK** on the telephone base.
 - To return to idle mode, press and hold **CANCEL**.

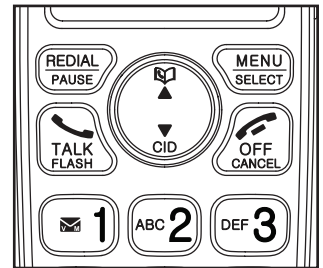
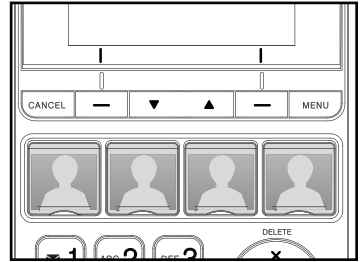

Ringer volume

Telephone base ringer volume:

- Press ▼VOL or ▲VOL when idle.

Handset ringer volume:

- Press VOL+ or VOL- when idle.

Pendant ringer volume:

- Press VOL+ or VOL- when idle.

Telephone settings

Ringer tone

Cordless handset/telephone base ringer tone:

1. Press **MENU** when idle.
2. Scroll to **Ringers**, then press **SELECT** on the cordless handset/**SELECT** on the telephone base.
3. Scroll to **Ringer tone**, then press **SELECT** on the cordless handset/**SELECT** on the telephone base.
4. Scroll to sample each ringer tone.
5. Press **SELECT** on the cordless handset/**SELECT** on the telephone base.



Pendant ringer tone:

1. Press **MENU** when idle.
2. Scroll to **Pendant**, then press **SELECT** on the cordless handset/**SELECT** on the telephone base.
3. Scroll to **Pendant ringer**, then press **SELECT** on the cordless handset/**SELECT** on the telephone base.
4. Scroll to sample each ringer tone.
5. Press **SELECT** on the cordless handset/**SELECT** on the telephone base.

Telephone settings

Set date and time

The answering system announces the date and time of each message prior to playing it. Before using the answering system or reminder, set the date and time as follows. If you subscribe to caller ID service, the day, month and time are set automatically with each incoming call. Make sure the settings are correct so that the reminder feature works properly.

1. Press **MENU** when idle.
2. Scroll to **Set date/time**, then press **SELECT** on the cordless handset/**SELECT** on the telephone base.
3. Enter the month, date and year, then press **SELECT** on the cordless handset/**NEXT** on the telephone base.
4. Enter the hour and minute, then scroll to select **AM** or **PM**.
5. Press **SELECT** on the cordless handset/**SAVE** on the telephone base.

Voice Announce[®] caller ID

The voice announce caller ID feature lets you know who's calling without having to look at the display.

1. Press **MENU** when idle.
2. Scroll to **Annc Caller ID**, then press **SELECT** on the cordless handset/**SELECT** on the telephone base.
3. Scroll to the desired option, then press **SELECT** on the cordless handset/**SELECT** on the telephone base.
 - **Set all On/Off** - Change the setting for all devices.
 - **Local handset** - Change the setting for that handset only.
 - **Base** - Change the setting for the telephone base only.
 - **Pendant** - Change the setting for the pendant only.
4. Scroll to **On** or **Off**, then press **SELECT** on the cordless handset/**SELECT** on the telephone base.

Telephone settings

LCD language

You can select a language (English, French or Spanish) to be used in all screen displays.



1. Press **MENU** when idle.
2. Scroll to **Settings**, then press **SELECT** on the cordless handset/**SELECT** on the telephone base.
3. Press **SELECT** on the cordless handset/**SELECT** on the telephone base to select **LCD language**.
4. Scroll to select **English**, **Français** or **Español**, then press **SELECT** on the cordless handset/**SELECT** on the telephone base.
5. Press **SELECT** on the cordless handset/**YES** on the telephone base.

Talking digit

You can select the volume or turn off the audible spoken tone that is spoken when you press the dialing key during predialing.

1. Press **MENU** when idle.
2. Scroll to **Settings**, then press **SELECT** on the cordless handset/**SELECT** on the telephone base.
3. Scroll to **Talking Digit**, then press **SELECT** on the cordless handset/**SELECT** on the telephone base.
4. Scroll to sample each volume level, then press **SELECT** on the cordless handset/**SET** on the telephone base.

Voicemail number

Save your voicemail number to  **1** for quick access. The voicemail number is shared by all devices. Press and hold  **1** to retrieve voicemail from your service provider.

1. Press and hold  **1** when idle.
2. Enter the voicemail access number provided by your telephone service provider (up to 30 digits) when prompted.
3. Press **SELECT** on the cordless handset /**SAVE** on the telephone base.

Telephone settings

Clear voicemail indicators

Use this feature when the telephone indicates that there is new voicemail but there are none. This feature only turns off the indicators, **New voicemail** and . It does not delete your voicemail messages. As long as you have new voicemail messages, your telephone service provider continues to send the signal to turn on the indicators.

1. Press **MENU** when idle.
2. Scroll to **Settings**, then press **SELECT** on the cordless handset/**SELECT** on the telephone base.
3. Scroll to **Clr voicemail/Clear voicemail**, then press **SELECT** on the cordless handset/**SELECT** on the telephone base.
4. Press **SELECT** on the cordless handset/**YES** on the telephone base.

Rename base/handset

You can create a name for each system handset and the telephone base.

1. Press **MENU** when idle.
2. Scroll to **Settings**, then press **SELECT** on the cordless handset/**SELECT** on the telephone base.
3. Scroll to **Rename handset** or **Rename base**, then press **SELECT** on the cordless handset/**SELECT** on the telephone base.
4. Enter the desired name, then press **SELECT** on the cordless handset/**SAVE** on the telephone base.

Telephone settings

Key tone

The handset/telephone base is set to beep with each key press. You can set the key tone volume or turn the key tone off for each handset and the telephone base.

1. Press **MENU** when idle.
2. Scroll to **Settings**, then press **SELECT** on the cordless handset/**SELECT** on the telephone base.
3. Scroll to **Key tone**, then press **SELECT** on the cordless handset/**SELECT** on the telephone base.
4. Scroll to sample each volume level, then press **SELECT** on the cordless handset/**SET** on the telephone base.

Use caller ID to automatically set date and time

If you subscribe to caller ID service, the day, month and time are set automatically with each incoming call. Follow the steps below to turn the **CID time sync** feature on or off. The default setting is **On**.

1. Press **MENU** when idle.
2. Scroll to **Settings**, then press **SELECT** on the cordless handset/**SELECT** on the telephone base.
3. Scroll to **CID time sync**, then press **SELECT** on the cordless handset/**SELECT** on the telephone base.
4. Scroll to **On** or **Off**, then press **SELECT** on the cordless handset/**SELECT** on the telephone base.

Telephone settings

Home area code

If you dial your local calls using only seven digits (area code not required), you can program your home area code so that when you receive a call within your local area, the telephone number is automatically stored without the area code in the caller ID log.

1. Press **MENU** when idle.
2. Scroll to **Settings**, then press **SELECT** on the cordless handset/**SELECT** on the telephone base.
3. Scroll to **Home area code**, then press **SELECT** on the cordless handset/**SELECT** on the telephone base.
4. Enter a three-digit home area code, then press **SELECT** on the cordless handset/**SAVE** on the telephone base.

Dial mode

The dial mode is preset to touch-tone dialing. If you have pulse (rotary) service, you must change the dial mode to pulse dialing before using the telephone to make a call.

1. Press **MENU** when idle.
2. Scroll to **Settings**, then press **SELECT** on the cordless handset/**SELECT** on the telephone base.
3. Scroll to **Dial mode**, then press **SELECT** on the cordless handset/**SELECT** on the telephone base.
4. Scroll to select **Touch-tone** or **Pulse**, then press **SELECT** on the cordless handset/**SELECT** on the telephone base.

Telephone settings

Quiet mode

You can turn on the quiet mode for a period of time (1-12 hours). During this period, all tones (except paging tone) and call screening are muted.

When you turn on the quiet mode, the answering system turns on automatically. When the quiet mode duration expires, the answering system remains on.

To set and turn the quiet mode on:

1. Press and hold **QUIET#** on the cordless handset/**QUIET#** on the telephone base when idle. The screen shows **Quiet: _ _ hours (1-12 hours)**.
2. Enter the desired duration (1-12), then press **SELECT** on the cordless handset/**SELECT** on the telephone base.

To turn the quiet mode off:

- While the quiet mode is on, press and hold **QUIET#** on the cordless handset/**QUIET#** on the telephone base.

Happy message

Happy messages are pendant greeting messages. The default setting is **On**.

1. Press **MENU** when idle.
2. Scroll to **Pendant**, then press **SELECT** on the cordless handset/**SELECT** on the telephone base.
3. Scroll to **Happy message**, then press **SELECT** on the cordless handset/**SELECT** on the telephone base.
4. Scroll to **On** or **Off**, then press **SELECT** on the cordless handset/**SAVE** on the telephone base.

Telephone settings

Voice command

You can turn the pendant voice command feature (see pages 59-60) on or off.

1. Press **MENU** when idle.
2. Scroll to **Pendant**, then press **SELECT** on the cordless handset/**SELECT** on the telephone base.
3. Scroll to **Voice command**, then press **SELECT** on the cordless handset/**SELECT** on the telephone base.
4. Scroll to **On** or **Off**, then press **SELECT** on the cordless handset/**SAVE** on the telephone base.

Telephone operation

Make, answer and end a call

To make a call at the telephone base:

1. Lift the corded handset, or press **SPEAKER** .
2. When you hear a dial tone, dial the number.



To answer a call at the telephone base:

- Lift the corded handset, or press **SPEAKER**  or any dialing key.



To end a call at the telephone base:

- When you are using the corded handset, place it on the telephone base.
- When you are using the base speakerphone, press **SPEAKER** .

To make a call on a cordless handset:

1. Press  or .
2. When you hear a dial tone, dial the number.

To answer a call on a cordless handset:

- Press   or any dialing key.

To end a call on a cordless handset:

- Press **OFF** or place the handset in the handset charger.

To make a call on a pendant:

- Press **1** or **2** to dial the corresponding speed dial number.

To answer a call on a pendant:

- Press .

To end a call on a pendant:

- Press  or place the pendant in the pendant charger.

Telephone operation

Speakerphone

Handset speakerphone:

- When the cordless handset is on a call, press **⏮** to switch between the handset speakerphone and the handset earpiece.

Telephone base speakerphone:

- When the corded handset is on a call, press **SPEAKER ⏮** to switch between the telephone base speakerphone and the corded handset.

Equalizer

The equalizer enables you to change the quality of the audio for both handset earpiece and speakerphone to best suit your hearing. The default setting is **Natural**.

1. Press **MENU** during a call.
2. Press **SELECT** on the cordless handset/**SELECT** on the telephone base to choose **Equalizer**.
3. Scroll to **Natural**, **Treble 1**, **Treble 2** or **Bass**, then press **SELECT** on the cordless handset/**SAVE** on the telephone base.

Audio Assist[®]

Use the audio assist feature to enhance the clarity and loudness of your caller's voice on the cordless/corded handset earpiece when you are listening to a message or an announcement.

To turn on Audio Assist[®]:

- While you are on a call or listening to a message or an announcement using the cordless/corded handset earpiece, press **AUDIO ASSIST**.

To turn off Audio Assist[®]:

- Press **AUDIO ASSIST** again.

Audio Assist[®] is a registered trademark of Advanced American Telephones.

Telephone operation

Volume control

To adjust the listening volume on a cordless handset:

- During a call, press **VOL-** or **VOL+**.

To adjust the listening volume at the telephone base:

- During a call, press **▼VOL** or **▲VOL**.

To adjust the listening volume at a pendant:

- During a call, press **VOL-** or **VOL+**.

Mute

The mute function allows you to hear the other party but the other party cannot hear you.

To mute a call on a cordless handset:

- During a call, press **MUTE**.
- Press **MUTE** again to resume the conversation.

To mute a call at the telephone base:

- During a call, press **MUTE**.
- Press **UNMUTE** to resume the conversation.

Call waiting

If you subscribe to call waiting service from your telephone service provider, you hear an alert tone when there is an incoming call while you are already on another call.

- Press **FLASH** to put your current call on hold and take the new call.
- Press **FLASH** to switch back and forth between calls.

Telephone operation

Temporary ringer silencing

When the telephone is ringing, you can temporarily silence the ringer of the handset, pendant or the telephone base without disconnecting the call. The next call rings normally at the preset volume.

To silence the ringer temporarily on a cordless handset:

- Press **MUTE**, **CANCEL** or **QUIET**.

To silence the ringer temporarily at the telephone base:

- Press **MUTE**, **CANCEL** or **QUIET**.



To silence the ringer temporarily on a pendant:

- Press **VOL-**.

Redial

The last 10 telephone numbers dialed (up to 30 digits) are stored in the system memory.

To review and dial a redial number on a cordless handset:



1. Press **REDIAL** when idle.
2. Press **▼**, **▲** or **REDIAL** repeatedly to browse.
3. When the desired entry displays, press  or  to dial.

To review and dial a redial number at the telephone base:

1. Press **REDIAL** when idle.
2. Press **▼**, **▲** or **REDIAL** repeatedly to browse.
3. When the desired entry displays, lift the corded handset or press **SPEAKER**  to dial.

Temporary tone dialing

If you have pulse (rotary) service only, you can switch from pulse to touch-tone dialing temporarily during a call. This is useful if you need to send touch-tone signals to access your telephone banking or long distance services.

1. During a call, press **TONES**  **A** .
2. Enter the number you wish to dial. The telephone sends touch-tone signals. It automatically returns to pulse dialing mode after you end the call.

Telephone operation

Check voicemail

- Press and hold  **1** on the cordless handset/telephone base to dial your voicemail number.

Chain dialing

Use this feature on the cordless handsets or the telephone base to initiate a dialing sequence from numbers stored in the phonebook, caller ID log or redial list while you are on a call.

To access a number from the phonebook while on a call:

1. Press **MENU**.
2. Scroll to **Phonebook**, then press **SELECT** on the cordless handset/**SELECT** on the telephone base.
3. Scroll to the desired entry, then press **SELECT** on the cordless handset/**CALL** on the telephone base to dial.

To access a number from the caller ID log while on a call:

1. Press **MENU**.
2. Scroll to **Caller ID log**, then press **SELECT** on the cordless handset/**SELECT** on the telephone base.
3. Scroll to the desired entry, then press **SELECT** on the cordless handset/**CALL** on the telephone base to dial.

To access a number from the redial list while on a call:

1. Press **REDIAL** to enter the redial list.
2. Press **▼**, **▲** or **REDIAL** repeatedly to browse to the desired entry.
3. Press **SELECT** on the cordless handset/**CALL** on the telephone base to dial.

Telephone operation



Transfer a call

While on an outside call, you can transfer the call from a cordless handset or the telephone base to another system device.

To transfer a call from a cordless handset:

1. During a call, press **MENU**. Scroll to **Transfer**, then press **SELECT**.
 - If you have two or more handsets/pendants, scroll to the desired device and then press **SELECT**.

The outside call is put on hold and the handset shows **Transferring call/Transferring call to all**. The destination device rings.

2. To answer the call on the destination handset, press   or any dialing key.

-OR-

To answer the call on the telephone base, lift the corded handset, or press **SPEAKER**  or any dialing key.



-OR-

To answer the call on the pendant, press .

To transfer a call from the telephone base:

1. During a call, press **MENU**. Scroll to **Transfer**, then press **SELECT**.
 - If you have two or more handsets/pendants, scroll to the desired device and then press **SELECT**.

The outside call is put on hold and the telephone base shows **Transferring call/Transferring call to all**. The destination device rings.

2. To answer the call on the destination handset, press   or any dialing key.

-OR-

To answer the call on the pendant, press .

Telephone operation

Find handset/pendant

This feature helps you find misplaced handsets and pendants.

To start the paging tone:

- Press **FIND HS** on the right side of the telephone base and its screen displays **Paging all devices**. All idle handsets and pendants ring and the handsets screens display **** Paging ****.

To stop the paging tone:

- Press  or any dialing key on a cordless handset, or return the cordless handset to its charger.

-OR-

- Press  on a pendant.

-OR-

- Press **STOP**, **CANCEL** or **FIND HS** on the telephone base.

note



Press **MUTE** to mute the ringer of other handsets or press **VOL-** to mute the ringer of other pendants until you find the missing handset or pendant.

Multiple handset use



Join a call in progress

Another handset, pendant or the telephone base can join an outside call. You can share an outside call with the telephone base and up to four handsets/pendants at the same time.



To join a call with a cordless handset:

- Press  or  to join the call.
- Press **OFF** or place the handset in the handset charger to exit the call.

To join a call with the telephone base:

- Lift the corded handset or press **SPEAKER** .
- Return the corded handset to the telephone base or press **SPEAKER**  to exit the call.

To join a call with a pendant:

- Press  to join the call.
- Press  or place the pendant in the pendant charger to exit the call.

Multiple handset use



Intercom

Use the intercom feature for conversations between two system devices.

To initiate an intercom call with a cordless handset:

1. Press **MENU**, then scroll to **Intercom**, then press **SELECT**. Scroll to the desired device and press **SELECT**. Your handset shows **Calling HANDSET X/Calling BASE 0/Calling all pendants/Calling all devices**.

The destination device rings. The destination handset/telephone base shows **HANDSET X is calling**.

2. To answer the intercom call on the destination handset, press ,  or any dialing key.

-OR-

To answer the intercom call at the telephone base, press **SPEAKER**  or any dialing key, or lift the corded handset.

-OR-

To answer the intercom call on a pendant, press .

3. To end the intercom call on either handset, one party presses **OFF**, or places the handset back in the handset charger.

-OR-

To end the intercom call at the telephone base, press **END**, **CANCEL** or **SPEAKER**  when you are using the base speakerphone, or return the corded handset to the telephone base.

-OR-

To end the intercom call on the pendant, press  or place the pendant back in the pendant charger.

Multiple handset use

To initiate an intercom call at the telephone base:

1. Press **MENU**, then scroll to **Intercom**, then press **SELECT**. Scroll to the desired device and press **SELECT**. The telephone base shows **Calling HANDSET X/Calling all pendants/Calling all devices**.

The destination device rings. The destination handset shows **BASE 0 is calling**.

2. To answer the intercom call on the destination handset, press  or any dialing key.

-OR-

To answer the intercom call on the pendant, press .

3. To end the intercom call at the telephone base, press **END**, **CANCEL** or **SPEAKER**  when you are using the base speakerphone, or return the corded handset to the telephone base.

-OR-

To end the intercom call on the destination handset, one party presses **OFF**, or places the handset back in the handset charger.

-OR-

To end the intercom call at the pendant, press  or place the pendant back in the pendant charger.

Phonebook

The phonebook stores up to 50 entries, which are shared by all devices.

Add a phonebook entry

1. Press **MENU** when idle.
2. Scroll to **Phonebook**, then press **SELECT** on the cordless handset/**SELECT** on the telephone base.
3. Scroll to **Add contact**, then press **SELECT** on the cordless handset/**SELECT** on the telephone base.
4. Enter a number.

-OR-

Copy a number from the redial list by pressing **REDIAL** then ▼ or ▲, or pressing **REDIAL** repeatedly to find the desired number. Press **SELECT** on the cordless handset/**SELECT** on the telephone base to copy the number.

5. Press **SELECT** on the cordless handset/**NEXT** on the telephone base.
6. Enter a name, then press **SELECT** on the cordless handset/**SAVE** on the telephone base.

Review phonebook entries

Phonebook entries appear alphabetically.



1. Press  on the cordless handset or **PHONEBOOK** on the telephone base when idle to show the first entry in the phonebook.
2. Press ▼ or ▲ to browse through the entries.

Alphabetical search

1. Press  on the cordless handset or **PHONEBOOK** on the telephone base when idle to show the first entry in the phonebook.
2. Use the dialing keys to enter the letter associated with the name. For example, if you have the entries named Jennifer, Jessie, Kevin and Linda in your phonebook, press **5** (JKL) once to see Jennifer (when Jennifer displays, press ▼ to see Jessie), twice to see Kevin, or three times to see Linda. If necessary, press ▼ or ▲ to browse.

Phonebook

Dial a phonebook entry

1. Search for the desired entry in the phonebook (see **Review phonebook entries** or **Alphabetical search** on page 39).
2. When the desired entry displays, press  or  on the handset, or **SPEAKER**  on the telephone base to dial.

Edit a phonebook entry

1. Search for the desired entry in the phonebook (see **Review phonebook entries** or **Alphabetical search** on page 39). Press **SELECT** on the cordless handset/**EDIT** on the telephone base.
2. Edit the number, then press **SELECT** on the cordless handset/**NEXT** on the telephone base.
3. Edit the name, then press **SELECT** on the cordless handset/**SAVE** on the telephone base.

Delete a phonebook entry

- To delete the displayed phonebook entry, press **DELETE**. Then press **SELECT** on the cordless handset/**YES** on the telephone base to confirm. You cannot retrieve a deleted entry.

Photo speed dial

The telephone system has four photo speed dial locations, where you can store the telephone numbers you wish to dial more quickly. You can store up to 30 digits in each location. You must set the speed dial numbers to the corresponding locations before using them.

We recommend you store two contacts that you may need to call them more often or right away to photo speed keys **1** and **2**.

Store a photo speed dial entry

1. Press **MENU** on the telephone base when idle.
2. Scroll to **Photo speed dial**, press **SELECT**.
3. Scroll to the desired speed dial location, then press **SELECT**.
4. Enter a number, then press **NEXT**.
5. Enter a name, then press **SAVE**.

Edit a photo speed dial entry

1. Press **MENU** on the telephone base when idle.
2. Scroll to **Photo speed dial**, press **SELECT**.
3. Edit the number, then press **NEXT**.
4. Edit the name, then press **SAVE**.

Delete a photo speed dial entry

1. Press **MENU** on the telephone base when idle.
2. Scroll to **Photo speed dial**, press **SELECT**.
3. Scroll to the location you wish to delete, then press **DELETE**.
4. Press **YES** to confirm.

Photo speed dial

Dial a photo speed dial number

To dial with the telephone base:

- Press a photo speed dial key to dial the number stored in the corresponding photo speed dial location.

To dial with the pendant:

- Press **1** or **2** to dial the number stored in the corresponding photo speed dial location.

-OR-

Use the voice command feature to dial (see page 59).

Caller ID

The caller ID log stores up to 50 entries, which are shared by all system devices.

Missed call indicator

When there are calls that have not been reviewed in the caller ID log, the screens display **XX Missed calls**. When you have reviewed all the missed calls, the missed call indicator goes away.

Each time you review a caller ID log entry marked **NEW** on the cordless handset or **NEW** on the telephone base, the number of missed calls decreases by one.

If you do not want to review the missed calls one by one, press and hold **CANCEL** or **DELETE** on the cordless handset or **CANCEL** on the telephone base when not in use to clear the missed call indicator. All the entries are then considered old and kept in the caller ID log.

Review the caller ID log

Review the caller ID log to find out who called, to return the call, or to copy the caller's name and number into your phonebook.

To review the caller ID log with a cordless handset/the telephone base:

1. Press **CID** on the cordless handset, or press **CALL LOG** on the telephone base when idle.
2. Press ▼ or ▲ to browse.

To review the caller ID log with a pendant:

- Use the voice command feature (see page 60).

Caller ID

View dialing options

While reviewing the caller ID log, press **QUIET#** on the cordless handset or **QUIET#** on the telephone base repeatedly to display different dialing options for local and long distance numbers before dialing or saving the telephone number in the phonebook.

Press **1** repeatedly if you need to add or remove 1 in front of the telephone number before dialing or saving it in the phonebook.

When the number is displayed in the correct format for dialing, press **TALK** or **SPEAKER** or lift the corded handset on the telephone base to dial.

Save a caller ID log entry to the phonebook

1. Search for the desired caller ID log entry (see **Review the caller ID log** on page 43).
2. Press **SELECT** on the cordless handset/**SELECT** on the telephone base to choose an entry.
3. Edit the number, then press **SELECT** on the cordless handset/**NEXT** on the telephone base.
4. Edit the name, then press **SELECT** on the cordless handset/**SAVE** on the telephone base.

Reminder

About the reminder

The reminder feature helps remind you of important events. You can set the reminder to remind you only once, or in daily, weekly or monthly bases. Once you set the reminder, the system will alarm you at the alarm time and every 15 minutes after the alarm time for three more times.

Add a reminder

Each reminder can be up to four minutes in length. The total storage capacity for the announcement, messages, memos and reminders is approximately 14 minutes.

To add a reminder with a cordless handset:

1. Press **MENU** when idle.
2. Scroll to **Reminder**, then press **SELECT**.
3. Scroll to **Set reminder**, then press **SELECT**.
4. Enter the month, date and year, then press **SELECT**.
5. Enter the hour and minute, then scroll to select **AM** or **PM**, then press **SELECT**.
6. The system announces, *“Record after the tone. Press 5 when you are done.”* After the tone, speak towards the microphone.
7. Press **5** when done.
8. Scroll to the frequency you would like to set, then press **SELECT**.

To add a reminder with the telephone base:

1. Press **MENU** when idle.
2. Scroll to **Reminder**, then press **SELECT**.
3. Scroll to **Set reminder**, then press **SELECT**.
4. Enter the month, date and year, then press **NEXT**.
5. Enter the hour and minute, then scroll to select **AM** or **PM**, then press **NEXT**.
6. The system announces, *“Record after the tone. Press SAVE when you are done.”* After the tone, speak towards the microphone.
7. Press **SAVE** when done.
8. Scroll to the frequency you would like to set, then press **SAVE**.

Reminder

Review reminders

When playback begins, the total number of reminders is announced. Before each reminder, you hear the day and time of the recording. After the last reminder, the screen displays **End of reminder** and you hear, *“End of reminder.”*

To play reminders with a cordless handset:

1. Press **MENU** when idle.
2. Scroll to **Reminder**, then press **SELECT**.
3. Press **SELECT** to select **Review**. The reminders play automatically.

To play reminders with the telephone base:

1. Press **MENU** when idle.
2. Scroll to **Reminder**, then press **SELECT**.
3. Press **SELECT** to select **Review reminder**. The reminders play automatically.

To play reminders with a pendant:

Use the voice command feature (see page 59).

Add and review reminders remotely

You can also add or review reminders remotely from any touch-tone telephone. See **Remote access** on page 58 for more information.

Answering system settings

Answering system

Use the answering system menu of a cordless handset or telephone base to turn on or off the answering system or message alert tone, set up the announcement message, activate the call screening, or change the number of rings, remote access code and message recording time.

Announcement

The telephone is preset with a greeting that answers calls with, *“Hello. Please leave a message after the tone.”* You can use this preset announcement, or replace it with your own.

Record your own announcement

You can record an announcement up to 90 seconds, but any announcement shorter than two seconds will not be recorded.

To record an announcement with a cordless handset:

1. Press **MENU** when idle.
2. Scroll to **Answering sys**, then press **SELECT**.
3. Press **SELECT** again to select **Announcement**.
4. Press **SELECT** again to select **Record annnc**. The system announces, *“Record after the tone. Press 5 when you are done.”* After the tone, speak towards the microphone.
5. Press **5** when done.

To record an announcement with the telephone base:

1. Press **MENU** when idle, then press **SELECT** to select **Answering system**.
2. Press **SELECT** again to select **Announcement**.
3. Press **SELECT** again to select **Record new annnc**. The system announces, *“Record after the tone. Press SAVE when you are done.”* After the tone, speak towards the microphone.
4. Press **SAVE** when done.

Answering system settings

Answer on/off

The answering system must be turned on to answer and record messages.

When the answering system is turned on, the **ANS**  light on the telephone base turns on and **ANS ON** displays on the cordless handset.

To set answer on/off with a cordless handset:

1. Press **MENU** when idle.
2. Scroll to **Answering sys**, then press **SELECT**.
3. Scroll to **Answer ON/OFF**, then press **SELECT**.
4. Scroll to **On** or **Off**, then press **SELECT**.

To set answer on/off with the telephone base:

- Press **ANS**  to turn the answering system on or off.

Call screening

Use this feature to choose whether incoming messages can be heard over the cordless handset or the telephone base while they are being recorded.

To set call screening on/off with a cordless handset:

1. Press **MENU** when idle.
2. Scroll to **Answering sys**, then press **SELECT**.
3. Scroll to **Ans sys setup**, then press **SELECT**.
4. Press **SELECT** again to select **Call screening**.
5. Scroll to **On** or **Off**, then press **SELECT**.

To set call screening on/off with the telephone base:

1. Press **MENU** when idle, then press **SELECT** to select **Answering system**.
2. Scroll to **Ans sys setup**, then press **SELECT**.
3. Press **SELECT** again to select **Call screening**.
4. Scroll to **On** or **Off**, then press **SAVE**.

Answering system settings

Number of rings

You can choose two, three, four, five or six rings, or toll saver. With toll saver selected, the answering system answers after two rings if you have new messages, or after four rings when there are no new messages. This enables you to check for new messages and avoid paying long distance charges when calling from out of your local area.

To set number of rings with a cordless handset:

1. Press **MENU** when idle.
2. Scroll to **Answering sys**, then press **SELECT**.
3. Scroll to **Ans sys setup**, then press **SELECT**.
4. Scroll to **# of rings**, then press **SELECT**.
5. Scroll to select **6, 5, 4, 3, 2** or **Toll saver**, then press **SELECT**.

To set number of rings with the telephone base:

1. Press **MENU** when idle, then press **SELECT** to select **Answering system**.
2. Scroll to **Ans sys setup**, then press **SELECT**.
3. Scroll to **# of rings**, then press **SELECT**.
4. Scroll to select **6, 5, 4, 3, 2** or **Toll saver**, then press **SAVE**.

Answering system settings

Remote access code

A two-digit security code is required to access the answering system remotely from any touch-tone telephone. The preset code is **19**. You can set the code from **00** to **99**.

To set remote access code with a cordless handset:

1. Press **MENU** when idle.
2. Scroll to **Answering sys**, then press **SELECT**.
3. Scroll to **Ans sys setup**, then press **SELECT**.
4. Scroll to **Remote code**, then press **SELECT**.
5. Enter a two-digit number, then press **SELECT**.

To set remote access code with the telephone base:

1. Press **MENU** when idle, then press **SELECT** to select **Answering system**.
2. Scroll to **Ans sys setup**, then press **SELECT**.
3. Scroll to **Remote code**, then press **SELECT**.
4. Enter a two-digit number, then press **SAVE**.

Message alert tone

When the message alert tone is set to **On**, and there is at least one new message, the telephone base beeps every 10 seconds. The message alert tone is preset to **Off**.

There is no audible alert at the handset.

To set message alert tone with a cordless handset:

1. Press **MENU** when idle.
2. Scroll to **Answering sys**, then press **SELECT**.
3. Scroll to **Ans sys setup**, then press **SELECT**.
4. Scroll to **Msg alert tone**, then press **SELECT**.
5. Scroll to **On** or **Off**, then press **SELECT**.

Answering system settings

To set message alert tone with the telephone base:

1. Press **MENU** when idle, then press **SELECT** to select **Answering system**.
2. Scroll to **Ans sys setup**, then press **SELECT**.
3. Scroll to **Msg alert tone**, then press **SELECT**.
4. Scroll to **On** or **Off**, then press **SAVE**.

Message recording time

You can set the recording time allowed for incoming messages. The message length is three minutes by default.

To set message recording time with a cordless handset:

1. Press **MENU** when idle.
2. Scroll to **Answering sys**, then press **SELECT**.
3. Scroll to **Ans sys setup**, then press **SELECT**.
4. Scroll to **Recording time**, then press **SELECT**.
5. Scroll to **3 minutes**, **2 minutes** or **1 minute**, then press **SELECT**.

To set message recording time with the telephone base:

1. Press **MENU** when idle, then press **SELECT** to select **Answering system**.
2. Scroll to **Ans sys setup**, then press **SELECT**.
3. Scroll to **Recording time**, then press **SELECT**.
4. Scroll to **3 minutes**, **2 minutes** or **1 minute**, then press **SAVE**.

Answering system operation

Answering system and voicemail

Your telephone has separate indicators for two different types of voice messages: those left on its built-in digital answering system and those left with your telephone service provider's voicemail (fees may apply). Your telephone's built-in digital answering system messages and voicemail messages are separate. Each alerts you to new messages differently.

- If ►/■/**PLAY/STOP** on the telephone base flashes, **XX New messages** displays on the cordless handsets and telephone base, there are new messages in the built-in answering system. To listen to the messages recorded on your digital answering system, press ►/■/**PLAY/STOP** on the telephone base.
- If ✉ and **New voicemail** display on the cordless handsets, or ✉ and **New voicemail** display on the telephone base, your telephone service provider is indicating that it has new voicemail for you. To listen to your voicemail, press and hold ✉ **1** on your handset/telephone base. See **Voicemail number** on page 23 to set your voicemail number.

Some telephone service providers bundle or combine multiple services like voicemail and call waiting, so you may not be aware that you have voicemail. To check what services you have and how to access them, contact your telephone service provider.

To use your voicemail service rather than your answering system, turn off your answering system. To use your answering system rather than your voicemail service, contact your telephone service provider to deactivate your voicemail service.

Answering system operation

Using the answering system and voicemail together

You can also use your telephone answering system and voicemail together by setting your built-in answering system to answer before voicemail answers as described below. To learn how to program your voicemail settings, contact your telephone service provider. Then, if you are on a call, or if the answering system is busy recording a message and you receive another call, the second caller can leave a voicemail message.

Set your answering system to answer calls at least two rings earlier than your voicemail is set to answer. For example, if your voicemail answers after six rings, set your answering system to answer after four rings. Some voicemail providers may program the delay before answering calls in seconds instead of rings. In this case, allow six seconds per ring when determining the appropriate setting.

Message capacity

The answering system can record and store up to 99 messages. Each message can be up to three minutes in length. The total storage capacity for the announcement, messages, memos and reminders is approximately 14 minutes. The actual recording time depends on individual message characteristics. Messages remain available for replay until you delete them.

Answering system operation

Call screening

To screen a call at the telephone base:

If the answering system and call screening are on, the announcement and the incoming message broadcast at the telephone base while the call is answered by the answering system.

Options while a message is being recorded:

- Press **▼VOL** or **▲VOL** to adjust the listening volume.
- Press **▶/■/STOP** to temporarily turn off the feature.
- Press **SILENCE** to temporarily mute the feature.
- Press **SCREEN** to temporarily turn on the feature if it is set to off.

To screen a call at a cordless handset:

If the answering system and call screening are on, press **SELECT**. The announcement and the incoming message broadcast at the handset while the call is answered by the answering system.

Options while a message is being recorded:

- Press **VOL+** or **VOL-** to adjust the listening volume.
- Press **OFF** to temporarily turn off the feature.
- Press **SELECT** to temporarily turn on the feature if it is set to off.

Call intercept

If you want to talk to the caller whose message is being recorded, press **TALK** or **◀»** on a cordless handset, or **SPEAKER** **◀»** on the telephone base, or lift the corded handset from the telephone base.

Temporarily turn off the message alert tone

If the message alert tone is turned on, the telephone base beeps every 10 seconds when there are new messages. Pressing any telephone base key (except **FIND HS**) temporarily silences the message alert tone.

The message alert tone resumes when you receive a new message.

Answering system operation

Message playback

To play messages on a cordless handset:

1. Press **MENU** when idle.
2. Press **SELECT** to select **Play messages**.
3. If you have only new or old messages, the messages play automatically.

-OR-

If you have both new and old messages, scroll to **Play new msgs** or **Play old msgs**, then press **SELECT**.

Options during playback:

- Press **VOL+** or **VOL-** to adjust the message playback volume.
- Press **6** to skip to the next message.
- Press **4** to repeat the message. Press **4** twice to hear the previous message.
- Press **DELETE** to delete the playing message.
- Press **◀**) to switch between speakerphone mode and handset mode.
- Press **TALK** to call back the caller. The screen displays **Call back?** Press **SELECT** to confirm or press **OFF** to cancel.
- Press **SELECT** to pause the playback and view the caller's information. Then you can press **TALK** or **◀**) to call back.

Answering system operation

To play messages at the telephone base:

1. Press **PLAY** when idle.
2. If you have only new or old messages, the messages play automatically.

-OR-

If you have both new and old messages, scroll to **Play new msgs** or **Play old msgs**, then press **SELECT**.

Options during playback:

- Press **▼VOL** or **▲VOL** to adjust the message playback volume.
- Press **▶▶/SKIP** to skip to the next message.
- Press **◀◀/REPEAT** to repeat the message. Press **◀◀/REPEAT** twice to hear the previous message.
- Press **X/DELETE** to delete the playing message.
- Press **▶/■/STOP** to stop the playback.
- Press **SLOW** to reduce the playback speed.
- Press **CALL BACK** to call back the caller. The screen displays **Call back?** Press **YES** to confirm or **NO** to cancel.

To play messages at a pendant:

- Use the voice command feature (see page 60).

Answering system operation

Delete all old messages

You can only delete old (reviewed) messages. You cannot delete new messages until you review them. You cannot retrieve deleted messages.

To delete all old messages with a cordless handset:

1. Press **MENU** when idle.
2. Scroll to **Answering sys**, then press **SELECT**.
3. Scroll to **Delete all old**, then press **SELECT**.
4. Press **SELECT** to confirm.

To delete all old messages with the telephone base:

1. Press **MENU** when idle, then press **SELECT** to select **Answering system**.
2. Scroll to **Delete all old**, then press **SELECT**.
3. Press **YES** to confirm.

Record, play and delete memos

Memos are your own recorded messages used as reminders for yourself or others using the same answering system. Play and delete them in the same way as incoming messages.

To record a memo with a cordless handset:

1. Press **MENU** when idle.
2. Scroll to **Answering sys**, then press **SELECT**.
3. Scroll to **Record memo**, then press **SELECT**.
4. The system announces, *“Record after the tone. Press 5 when you are done.”* After the tone, speak towards the microphone.
5. Press **5** when done.

To record a memo with the telephone base:

1. Press **MENU** when idle, then press **SELECT** to select **Answering system**.
2. Scroll to **Record memo**, then press **SELECT**.
3. The system announces, *“Record after the tone. Press **SAVE** when you are done.”* After the tone, speak towards the microphone.
4. Press **SAVE** when done.

Answering system operation

Remote access

A two-digit security code is required to access the answering system remotely from any touch-tone telephone. The preset code is **19**.

1. Dial your telephone number from any touch-tone telephone.
2. Enter the two-digit security code after the announcement and the long beep.
3. The system announces, “*Press star for reminder or press pound to listen to messages.*” Press ^{TO}_aA **X** or **#**.
 - After pressing ^{TO}_aA **X**, you can enter one of the following remote commands:

Command	Function
1	Review reminders.
2	Set reminders.
3	End the call.
4	Turn reminder off.

-OR-

- After pressing **#**, you can enter one of the following remote commands.

Command	Function
1	Play all messages.
2	Play new messages.
3	Delete the current message (during playback).
33	Delete all old messages.
4	Repeat the current message (during playback).
5	Stop.
*5	Hear a list of remote commands.
6	Skip to the next message (during playback).
*7	Record a new announcement.
8	End the call.
0	Turn the answering system on or off.

Voice command

About voice command

By saying certain commands to the pendant, you can hear information such as the date or time, or call photo speed dial numbers, or even review call log, messages or reminders.

Use voice command

Press **VOICE** on either side of the pendant when the telephone is idle. After you hear a beep, say your command to the pendant.

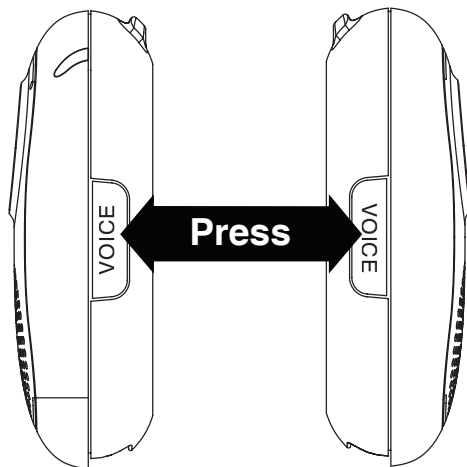

Common commands

"What can I say?" - To hear a list of voice commands.

"What time is it?" - To hear the current time.

"What is the date?" - To hear the current date.

"Call speed dial X." - To call a photo speed dial number.

"Intercom all." - To send out intercom request to all devices.

"Cancel." - To return to idle mode.

Reminders

Press **VOICE** and say *"Review reminders."*

During the playback, press **VOICE** and say one of the following commands:

"What can I say?" - To hear a list of voice commands.

"Skip reminder." - To skip to the next reminder.

"Repeat reminder." - To repeat the reminder.

"Stop." - To stop the reminder playback.

"Cancel." - To continue the reminder playback.

Voice command

Use voice command

Messages

Press **VOICE** and say *“Review messages.”*

During the playback, press **VOICE** and say one of the following commands:

“What can I say?” - To hear a list of voice commands.

“Skip message.” - To skip to the next message.

“Repeat message.” - To repeat the message.

“Slow playback.” - To slow down the message playback.

- To resume normal playback, press **VOICE** and say *“Play normal.”*

“Stop.” - To stop the message playback.

“Delete.” - To delete the current message.

“Cancel.” - To continue the message playback.

Call log

Press **VOICE** and say *“Review call log.”*

During the playback, press **VOICE** and say one of the following commands:

“What can I say?” - To hear a list of voice commands.

“Skip call log.” - To skip to the next call log entry.

“Repeat call log.” - To repeat the call log entry.

“Stop.” - To stop the call log entry playback.

“Cancel.” - To continue the call log entry playback.

“Call back.” - The system will ask, *“Would you like to call XXX?”*

- Say *“Yes”* to call the number.
 - Say *“No”* to return to the playback.
-

note

If you do not say the command within five seconds, or the system does not understand your command, the system will say, *“Sorry, I didn’t catch that. Please press the voice command button and try again.”*

Appendix

Handset battery

It takes up to 11 hours for the battery to be fully charged. When it is fully charged, you can expect the following performance:

Operation	Operating time
While in handset use (talking*)	Up to seven hours
While in speakerphone mode (talking*)	Up to five hours
While not in use (standby**)	Up to seven days

* Operating times vary depending on your actual use and the age of the battery.

** Handset is not charging or in use.

The battery needs charging when:

- A new battery is installed in the handset.
- The handset beeps.
- A battery is properly installed and the screen is blank.
- **Low battery** or **Place in charger** displays on the cordless handset screen.

CAUTION:

To reduce the risk of fire or injury, read and follow these instructions:

- Use only the batteries provided or equivalent. To order a replacement, go to www.vtechphones.com or call 1 (800) 595-9511. In Canada, go to www.vtechcanada.com or dial 1 (800) 267-7377.
- Do not dispose of the batteries in a fire. Check with local waste management codes for special disposal instructions.
- Do not open or mutilate the batteries. Released electrolyte is corrosive and may cause burns or injury to the eyes or skin. The electrolyte may be toxic if swallowed.
- Exercise care in handling batteries in order not to create a short circuit with conductive materials.
- Charge the batteries provided with or identified for use with this product only in accordance with the instructions and limitations specified in this manual.
- Observe proper polarity orientation between the battery and metallic contacts.
- To prevent fire or shock hazard, do not expose this product to water or any type of moisture.

Appendix

Pendant battery

It takes up to three hours for the battery to be fully charged. When it is fully charged, you can expect the following performance:

Operation	Operating time
While in speakerphone mode (talking*)	Up to five hours

* Operating time varies depending on your actual use and the age of the battery.

The battery needs charging when:

- You hear “*Low battery.*”
- There is an alert tone every one minute.
- The pendant status light flashes red or is solid red.

Conserve battery life:

The pendant battery is not replaceable.

If the pendant will not be used for a long period of time, switch **OFF** the pendant to conserve pendant battery life.

CAUTION:

To prevent fire or shock hazard, do not expose this product to water or any type of moisture.

Appendix

Troubleshooting

If you have difficulty with your telephone, please try the suggestions below. For customer service, visit our website at www.vtechphones.com or call 1 (800) 595-9511. In Canada, go to www.vtechcanada.com or dial 1 (800) 267-7377.

My telephone doesn't work at all.

- Make sure the power cord is securely plugged in.
- If there are backup batteries in the telephone base, make sure they are correctly installed.
- Make sure you plug the battery connector securely into the cordless handset.
- Make sure you plug the telephone line cord securely and firmly into the telephone base and the telephone wall jack.
- Charge the battery in the cordless handset for at least 11 hours. For optimum daily performance, return the cordless handset to the handset charger when not in use.
- Charge the pendant for at least 3 hours. For optimum daily performance, return the pendant to the pendant charger when not in use.
- Make sure you turn the pendant on before use.
- If the battery is completely depleted, charge the handset or the pendant for at least 30 minutes before use.
- Reset the telephone base. Unplug the electrical power. Take out the backup batteries if necessary. Wait for approximately 15 seconds, then plug it back in. Allow up to one minute for the cordless handset, pendant and telephone base to reset.
- You may need to purchase a new handset battery.

I cannot get a dial tone.

- Try all the suggestions above.
- Move the cordless handset or the pendant closer to the telephone base. You may have moved out of range.
- If the previous suggestions do not work, disconnect the telephone base from the telephone jack and connect to a different phone. If there is no dial tone on that phone either, the problem is in your wiring or telephone service. Contact your telephone service provider.
- Your line cord may be defective. Try installing a new line cord.

Appendix

Troubleshooting

I cannot dial out.

- Try all the suggestions above.
- Make sure you have a dial tone before dialing. The cordless handset or the pendant may take a second or two to find the telephone base and produce a dial tone. This is normal. Wait an extra second before dialing.
- Eliminate any background noise. Noise from a television, radio or other appliances might cause the phone to not dial out properly. If you cannot eliminate the background noise, first try muting the cordless handset before dialing, or dial from another room with less background noise.
- If other phones in your home are having the same problem, contact your telephone service provider (charges may apply).
- If you have changed your telephone service to digital service from a cable company or a VoIP service provider, the telephone line may need to be rewired to allow all existing telephone jacks to work. Contact your service provider for more information.

My cordless handset/pendant isn't performing normally.

- Make sure you plug the power cord securely into the telephone base. Plug the power adapter into a different, working electrical outlet without a wall switch.
- Move the cordless handset or the pendant closer to the telephone base. You may have moved out of range.
- Reset the telephone base. Unplug the electrical power. Take out the backup batteries if necessary. Wait for 15 seconds then plug the power cord back in, and reinstall the backup batteries. Allow up to one minute for the cordless handset/pendant and telephone base to reset.
- Other electronic products such as HAM radios and other DECT phones can cause interference with your cordless phone. Try installing your phone as far away as possible from these types of electronic devices.

Appendix

Troubleshooting

Out of range OR Base no power appears on my cordless handset.

- Ensure you plug the telephone base in properly and the power is on.
- Place the cordless handset closer to the telephone base for synchronization.
- Move the cordless handset closer to the telephone base. You may have moved out of range.
- Reset the telephone base. Unplug the electrical power. Wait for 15 seconds then plug it back in. Allow up to one minute for the cordless handset and telephone base to reset.
- Other electronic products such as HAM radios and other DECT phones can cause interference with your cordless phone. Try installing your phone as far away as possible from these types of electronic devices.

The handset battery does not accept charge while in the handset charger.

- If the cordless handset is in the handset charger and the charge light is not on, refer to **The charge light is off** on page 68.
- Charge the battery in the cordless handset for at least 11 hours. For optimum daily performance, return the cordless handset to the handset charger when not in use.
- If the battery is completely depleted, charge the handset for at least 30 minutes before use.
- You may need to purchase a new battery.

The pendant battery does not accept charge while in the pendant charger.

- If the pendant is in the pendant charger and the pendant status light is not on, refer to **The charge light is off** on page 68.
- Charge the battery in the pendant for at least 3 hours. For optimum daily performance, return the pendant to the pendant charger when not in use.
- If the battery is completely depleted, charge the pendant for at least 30 minutes before use.

Appendix

Troubleshooting

I have accidentally set my cordless handset/telephone base LCD language to Spanish or French, and I don't know how to change it back to English.

- Press **MENU**, then enter the code TO NE~~3~~BY A**364#**.

I get noise, static, or weak signals even when I'm near the telephone base.

- If you subscribe to high-speed Internet service (DSL - digital subscriber line) through your telephone line, you must install a DSL filter between the telephone line cord and the telephone wall jack. The filter prevents noise and caller ID problems as a result of DSL interference. Contact your DSL service provider for more information about DSL filters.
- You may be able to improve the performance of your cordless phone by installing your new telephone base as far as possible from any other existing cordless telephone system that may already be installed.
- Other electronic products such as HAM radios and other DECT phones can cause interference with your cordless phone. Try installing your phone as far away as possible from these types of electronic devices.
- Do not install this phone near a microwave oven or on the same electrical outlet. You may experience decreased performance while the microwave oven is operating.
- If you plug your phone in with a modem or a surge protector, plug the phone (or modem/surge protector) into a different location. If this does not solve the problem, relocate your phone or modem farther apart from one another, or use a different surge protector.
- Relocate your phone to a higher location. The phone may have better reception in a high area.
- If other phones in your home are having the same problem, contact your telephone service provider (charges may apply).

I experience poor sound quality when using the handset speakerphone.

- For increased sound quality while using the handset speakerphone, place the handset on a flat surface with the dialing keys facing up.

Appendix

Troubleshooting

I hear other calls while using my phone.

- Disconnect the telephone base from the telephone jack, and plug in a different telephone. If you still hear other calls, call your telephone service provider.

The telephone does not ring when there is an incoming call.

- Make sure that the ringer is not off.
- Make sure you plug in the telephone line cord securely into the telephone base and the telephone jack.
- Make sure you plug in the power cord securely.
- Make sure the backup batteries are correctly installed if necessary.
- The cordless handset/pendant may be too far from the telephone base.
- Charge the battery in the cordless handset for at least 11 hours. For optimum daily performance, return the cordless handset to the handset charger when not in use.
- Charge the pendant for at least three hours. For optimum daily performance, return the pendant to the pendant charger when not in use.
- You may have too many extension phones on your telephone line to allow all of them to ring simultaneously. Try unplugging some of the other phones.
- The layout of your home might be limiting the operating range. Try moving the telephone base to another location, preferably to a higher location.
- If other phones in your home are having the same problem, contact your telephone service provider (charges may apply).
- Test a working phone at the phone jack. If another phone has the same problem, contact your telephone service provider (charges may apply).
- Other electronic products such as HAM radios and other DECT phones can cause interference with your cordless phone. Try installing your phone as far away as possible from these types of electronic devices.
- Remove and install the cordless handset battery again. Place the cordless handset in the handset charger. Wait for the cordless handset to reestablish its connection with the telephone base. Allow up to one minute for this to take place.
- Your line cord may be defective. Try installing a new line cord.

Appendix

Troubleshooting

My calls cut in and out while I'm using my cordless handset/pendant.

- Other electronic products such as HAM radios and other DECT phones can cause interference with your cordless phone. Try installing your phone as far away as possible from these types of electronic devices.
- Do not install this phone near a microwave oven or on the same electrical outlet. You may experience decreased performance while the microwave oven is operating.
- If you plug your phone in with a modem or surge protector, plug the phone (or modem/surge protector) into a different location. If this does not solve the problem, relocate your phone or modem farther apart from one another, or use a different surge protector.
- Relocate your telephone base to a higher location. The phone may have better reception when installed in a high area.
- If other phones in your home are having the same problem, contact your telephone service provider (charges may apply).

The charge light is off.

- Make sure you plug the power and line cords in correctly and securely.
- Reset the telephone base. Unplug the electrical power. Take out the backup batteries if necessary. Wait for 15 seconds then plug the power cord back in, and reinstall the backup batteries. Allow up to one minute for the cordless handset/pendant and telephone base to reset.
- Clean the charging contacts on the cordless handset/pendant and the handset/pendant charger each month with a pencil eraser or cloth.
- Make sure that the handset battery is installed properly.

Appendix

Troubleshooting

My caller ID isn't working properly.

- Caller ID is a subscription service. You must subscribe to this service from your telephone service provider for this feature to work on your phone.
- The caller must be calling from an area that supports caller ID.
- Both your and your caller's telephone service providers must use caller ID compatible equipment.
- If you subscribe to high-speed Internet service (DSL - digital subscriber line) through your telephone line, you must install a DSL filter between the telephone line cord and the telephone wall jack. The filter prevents noise and caller ID problems resulting from DSL interference. Contact your DSL service provider for more information about DSL filters.

My telephone does not receive caller ID when on a call.

- Make sure you subscribe to caller ID with call waiting features from your telephone service provider. Caller ID feature works only if both you and the caller are in areas offering caller ID service, and if both telephone service providers use compatible equipment.

The messages on the answering system are incomplete.

- If a caller leaves a very long message, part of it may be lost when the answering system disconnects the call after the preset recording time.
- If the caller pauses for too long, the answering system stops recording and disconnects the call.
- If memory on the answering system becomes full during a message, the answering system stops recording and disconnects the call.
- If the caller's voice is very soft, the answering system may stop recording and disconnect the call.

The messages are very difficult to hear.

- Press **▲VOL** on the telephone base, or **VOL+** on the cordless handset, or **VOL+** on the pendant to increase the listening volume.

Appendix

Troubleshooting

The answering system does not answer after the correct number of rings.

- Make sure that the answering system is on. **ANS ON** should show on the cordless handset and **ANS**  light on the telephone base should be on.
- If toll saver is activated, the number of rings changes to two when you have new messages stored.
- If the memory is full or the system is off, the system will answer after 10 rings.
- In some cases, the answering system is affected by the ringing system used by your telephone service provider.
- If you subscribe to voicemail service, change the number of rings so that your answering system answers before your voicemail answers. To determine how many rings activate your voicemail, contact your telephone service provider.
- If there is a fax machine connected to the same telephone line, try disconnecting the fax machine. If that solves the problem, consult your fax machine documentation for information on compatibility with answering systems.

The telephone does not respond to remote commands.

- Make sure you enter your remote access code correctly.
- Make sure you are calling from a touch-tone phone. When you dial a number, you should hear tones. If you hear clicks, the phone is not a touch-tone telephone and cannot activate the answering system.
- The answering system may not detect the remote access code while your announcement is playing. Try waiting until the announcement is over before entering the code.
- There may be interference on the phone line you are using. Press dialing keys firmly.

Appendix

Troubleshooting

The answering system does not record messages.

- Make sure that the answering system is on. **ANS ON** should show on the cordless handset and **ANS**  light on the telephone base should be on.
- Make sure the memory of the answering system is not full.
- If you subscribe to voicemail service, change the number of rings so that your answering system answers before your voicemail answers. To determine how many rings activate your voicemail, contact your telephone service provider.
- If there is a fax machine connected to the same telephone line, try disconnecting the fax machine. If that solves the problem, consult your fax machine documentation for information on compatibility with answering systems.



The system announces *“Time and day not set.”*

- You need to reset the system clock.

The outgoing announcement is not clear.

- When you record your announcement, make sure you speak in a normal tone of voice, about nine inches from the handset or telephone base.
- Make sure there is no background noise (TV, music, etc.) while recording.

New voicemail and show on the cordless handset and New voicemail and show on the telephone base and I don't know why.

- Your telephone has both a built-in answering system and voicemail indication. If **New voicemail** and  appear on the cordless handset, and **New voicemail** and  appear on the telephone base, then your telephone has received a signal from your telephone service provider that you have a voicemail message waiting for you to retrieve from them. Contact your telephone service provider for more information on how to access your voicemail.

Appendix

Troubleshooting

I cannot retrieve voicemail messages.

- Your telephone has both a built-in answering system and voicemail indication. They are independent features and each alerts you to new messages differently. If you subscribe to voicemail service from your telephone service provider, contact your telephone service provider for more information on how to access your voicemail.

Common cure for electronic equipment.

If the telephone does not seem to be responding normally, do the following (in the order listed):

- Disconnect the power to the telephone base.
- Remove the telephone base backup batteries.
- Disconnect the cordless handset battery.
- Wait a few minutes.
- Connect power to the telephone base.
- Install the telephone base backup batteries again.
- Install the cordless handset battery again, and place the cordless handset into the handset charger.
- Wait for the cordless handset and the pendant to reestablish their connections with the telephone base. Allow up to one minute for this to take place.

Appendix

Important safety instructions

When using your telephone equipment, basic safety precautions should always be followed to reduce the risk of fire, electric shock and injury, including the following:

1. Read and understand all instructions.
2. Follow all warnings and instructions marked on the product.
3. Unplug this product from the wall outlet before cleaning. Do not use liquid or aerosol cleaners. Use a damp cloth for cleaning.
4. Do not use this product near water such as near a bath tub, wash bowl, kitchen sink, laundry tub or swimming pool, or in a wet basement or shower.
5. Do not place this product on an unstable table, shelf, stand or other unstable surfaces.
6. Slots and openings in the back or bottom of the telephone base, handset and pendant are provided for ventilation. To protect them from overheating, these openings must not be blocked by placing the product on a soft surface such as a bed, sofa or rug. This product should never be placed near or over a radiator or heat register. This product should not be placed in any area where proper ventilation is not provided.
7. This product should be operated only from the type of power source indicated on the marking label. If you are not sure of the type of power supply in your home or office, consult your dealer or local power company.
8. Do not allow anything to rest on the power cord. Do not install this product where the cord may be walked on.
9. Never push objects of any kind into this product through the slots in the telephone base or handset because they may touch dangerous voltage points or create a short circuit. Never spill liquid of any kind on the product.
10. To reduce the risk of electric shock, do not disassemble this product, but take it to an authorized service facility. Opening or removing parts of the telephone base or handset other than specified access doors may expose you to dangerous voltages or other risks. Incorrect reassembling can cause electric shock when the product is subsequently used.
11. Do not overload wall outlets and extension cords.

Appendix

Important safety instructions

12. Unplug this product from the wall outlet and refer servicing to an authorized service facility under the following conditions:
 - When the power supply cord or plug is damaged or frayed.
 - If liquid has been spilled onto the product.
 - If the product has been exposed to rain or water.
 - If the product does not operate normally by following the operating instructions. Adjust only those controls that are covered by the operation instructions. Improper adjustment of other controls may result in damage and often requires extensive work by an authorized technician to restore the product to normal operation.
 - If the product has been dropped and the telephone base/handset/pendant has been damaged.
 - If the product exhibits a distinct change in performance.
13. Avoid using a telephone (other than cordless) during an electrical storm. There is a remote risk of electric shock from lightning.
14. Do not use the telephone to report a gas leak in the vicinity of the leak. Under certain circumstances, a spark may be created when the adapter is plugged into the power outlet, or when the handset or pendant is replaced in its cradle. This is a common event associated with the closing of any electrical circuit. The user should not plug the phone into a power outlet, and should not put a charged handset or pendant into its cradle, if the phone is located in an environment containing concentrations of flammable or flame-supporting gases, unless there is adequate ventilation. A spark in such an environment could create a fire or explosion. Such environments might include: medical use of oxygen without adequate ventilation; industrial gases (cleaning solvents; gasoline vapors; etc.); a leak of natural gas; etc.
15. Only put the handset of your telephone next to your ear when it is in normal talk mode.
16. The power adapters are intended to be correctly oriented in a vertical or floor mount position. The prongs are not designed to hold the plug in place if it is plugged into a ceiling, under-the-table or cabinet outlet.

SAVE THESE INSTRUCTIONS

Appendix

Precautions for users of implanted cardiac pacemakers

Cardiac pacemakers (applies only to digital cordless telephones):

Wireless Technology Research, LLC (WTR), an independent research entity, led a multidisciplinary evaluation of the interference between portable wireless telephones and implanted cardiac pacemakers. Supported by the U.S. Food and Drug Administration, WTR recommends to physicians that:

Pacemaker patients



- Should keep wireless telephones at least six inches from the pacemaker.
- Should NOT place wireless telephones directly over the pacemaker, such as in a breast pocket, when it is turned ON.
- Should use the wireless telephone at the ear opposite the pacemaker.

WTR's evaluation did not identify any risk to bystanders with pacemakers from other persons using wireless telephones.

Note: The CareLine™ transmitter is a wireless telephone, and it should not be used in the pendant form (hanging from a necklace over the heart) by persons wearing pacemakers. Pacemaker patients should use the CareLine™ product in belt-clip form only.

Operating range

This cordless telephone operates with the maximum power allowed by the Federal Communications Commission (FCC). Even so, this handset/pendant and telephone base can communicate over only a certain distance - which can vary with the locations of the telephone base and handset, the weather, and the layout of your home or office.

When the handset is out of range, the handset displays **Out of range OR Base no power**. If there is a call while the handset is out of range, it may not ring, or if it does ring, the call may not connect well when you press . Move closer to the telephone base, then press  to answer the call.

If the handset moves out of range during a telephone conversation, there may be interference. To improve reception, move closer to the telephone base.

ECO mode

This power conserving technology reduces power consumption for optimal battery performance. The ECO mode activates automatically whenever the handset is synchronized with the telephone base.

Appendix

Energy-saving charging mode

When this mode is activated, all telephone functions, except handset battery charging, will be disabled.

To activate the energy-saving charging mode:

1. Unplug the telephone base power adapter from the power outlet. Make sure all handsets are plugged with charged batteries.
2. While you press and hold **FIND HS**, plug the telephone base power adapter back to the power outlet.
3. After about 20 seconds, when the **IN USE** light starts flashing, release **FIND HS** and then press it again within 2 seconds.

 When the phone successfully enters the energy-saving mode, the **IN USE** light turns off and all handsets display **To register HS, see manual**.

When the phone fails to enter this mode, repeat Step 1 through Step 3 above.

Note: The telephone base will be powered up as normal if you fail to press **FIND HS** within 2 seconds in Step 3.

To deactivate the energy-saving charging mode:

1. Unplug the telephone base adapter from the power outlet, then plug it back in. Then the telephone base is powered up as normal.
2. Register your handset and pendant back to the telephone base. See pages 9 through 10 for registration instructions.

Maintenance

Taking care of your telephone

Your telephone contains sophisticated electronic parts, so it must be treated with care.

Avoid rough treatment

Place the handset down gently. Save the original packing materials to protect your telephone if you ever need to ship it.

Avoid water

Your telephone can be damaged if it gets wet. Do not use the handset outdoors in the rain, or handle it with wet hands. Do not install the telephone base near a sink, bathtub or shower.

Electrical storms

Electrical storms can sometimes cause power surges harmful to electronic equipment. For your own safety, take caution when using electrical appliances during storms.

Appendix

Cleaning your telephone

Your telephone has a durable plastic casing that should retain its luster for many years. Clean it only with a soft cloth slightly dampened with water or mild soap. Do not use excess water or cleaning solvents of any kind.

Remember that electrical appliances can cause serious injury if used when you are wet or standing in water. If the telephone base should fall into water, **DO NOT RETRIEVE IT UNTIL YOU UNPLUG THE POWER CORD AND TELEPHONE LINE CORD FROM THE WALL.** Then remove the telephone by the unplugged cords.

About cordless telephones

- **Privacy:** The same features that make a cordless telephone convenient create some limitations. Telephone calls are transmitted between the telephone base and the cordless handset by radio waves, so there is a possibility that the cordless telephone conversations could be intercepted by radio receiving equipment within range of the cordless handset. For this reason, you should not think of cordless telephone conversations as being as private as those on corded telephones.
- **Electrical power:** The telephone base of this cordless telephone must be connected to a working electrical outlet. The electrical outlet should not be controlled by a wall switch. Calls cannot be made from the cordless handset if the telephone base is unplugged, switched off or if the electrical power is interrupted.
- **Potential TV interference:** Some cordless telephones operate at frequencies that may cause interference to televisions and VCRs. To minimize or prevent such interference, do not place the telephone base of the cordless telephone near or on top of a TV or VCR. If interference is experienced, moving the cordless telephone farther away from the TV or VCR often reduces or eliminates the interference.
- **Rechargeable batteries:** Exercise care in handling batteries in order not to create a short circuit with conducting material such as rings, bracelets and keys. The battery or conductor may overheat and cause harm. Observe proper polarity between the battery and the battery charger.
- **Nickel-metal hydride rechargeable batteries:** Dispose of these batteries in a safe manner. Do not burn or puncture the battery. Like other batteries of this type, if burned or punctured, they could release caustic material which could cause injury.

Appendix

The RBRC® seal



The RBRC® seal on the nickel-metal hydride battery indicates that VTech Communications, Inc. is voluntarily participating in an industry program to collect and recycle these batteries at the end of their useful lives, when taken out of service within the United States and Canada.

The RBRC® program provides a convenient alternative to placing used nickel-metal hydride batteries into the trash or municipal waste, which may be illegal in your area.

VTech's participation in RBRC® makes it easy for you to drop off the spent battery at local retailers participating in the RBRC® program or at authorized VTech product service centers. Please call **1 (800) 8 BATTERY™** for information on Ni-MH battery recycling and disposal bans/restrictions in your area. VTech's involvement in this program is part of its commitment to protecting our environment and conserving natural resources.

RBRC® is a registered trademark of Rechargeable Battery Recycling Corporation.



The RBRC® seal on the lithium-ion battery indicates that VTech Communications, Inc. is voluntarily participating in an industry program to collect and recycle these batteries at the end of their useful lives, when taken out of service within the United States and Canada.

The RBRC® program provides a convenient alternative to placing used lithium-ion batteries into the trash or municipal waste, which may be illegal in your area.

VTech's participation in RBRC® makes it easy for you to drop off the spent battery at local retailers participating in the RBRC® program or at authorized VTech product service centers. Please call **1 (800) 8 BATTERY™** for information on Li-ion battery recycling and disposal bans/restrictions in your area. VTech's involvement in this program is part of its commitment to protecting our environment and conserving natural resources.

RBRC® is a registered trademark of Rechargeable Battery Recycling Corporation.

Appendix

Limited warranty

What does this limited warranty cover?

The manufacturer of this VTech Product warrants to the holder of a valid proof of purchase (“Consumer” or “you”) that the Product and all accessories provided in the sales package (“Product”) are free from defects in material and workmanship, pursuant to the following terms and conditions, when installed and used normally and in accordance with the Product operating instructions. This limited warranty extends only to the Consumer for Products purchased and used in the United States of America and Canada.

What will VTech do if the Product is not free from defects in materials and workmanship during the limited warranty period (“Materially Defective Product”)?

During the limited warranty period, VTech’s authorized service representative will repair or replace at VTech’s option, without charge, a Materially Defective Product. If we repair the Product, we may use new or refurbished replacement parts. If we choose to replace the Product, we may replace it with a new or refurbished Product of the same or similar design. We will retain defective parts, modules, or equipment. Repair or replacement of the Product, at VTech’s option, is your exclusive remedy. VTech will return the repaired or replacement Products to you in working condition. You should expect the repair or replacement to take approximately 30 days.

How long is the limited warranty period?

The limited warranty period for the Product extends for ONE (1) YEAR from the date of purchase. If VTech repairs or replaces a Materially Defective Product under the terms of this limited warranty, this limited warranty also applies to repaired or replacement Product for a period of either (a) 90 days from the date the repaired or replacement Product is shipped to you or (b) the time remaining on the original one-year warranty; whichever is longer.

What is not covered by this limited warranty?

This limited warranty does not cover:

1. Product that has been subjected to misuse, accident, shipping or other physical damage, improper installation, abnormal operation or handling, neglect, inundation, fire, water or other liquid intrusion; or
2. Product that has been damaged due to repair, alteration or modification by anyone other than an authorized service representative of VTech; or
3. Product to the extent that the problem experienced is caused by signal conditions, network reliability, or cable or antenna systems; or
4. Product to the extent that the problem is caused by use with non-VTech accessories; or
5. Product whose warranty/quality stickers, product serial number plates or electronic serial numbers have been removed, altered or rendered illegible; or
6. Product purchased, used, serviced, or shipped for repair from outside the United States of America or Canada, or used for commercial or institutional purposes (including but not limited to Products used for rental purposes); or
7. Product returned without a valid proof of purchase (see item 2 on the next page); or
8. Charges for installation or set up, adjustment of customer controls, and installation or repair of systems outside the unit.

Appendix

Limited warranty

How do you get warranty service?

To obtain warranty in the United States of America, please visit our website at www.vtechphones.com or call 1 (800) 595-9511. In Canada, go to www.vtechcanada.com or dial 1 (800) 267-7377.

NOTE: Before calling for service, please review the user's manual - a check of the Product's controls and features may save you a service call.

Except as provided by applicable law, you assume the risk of loss or damage during transit and transportation and are responsible for delivery or handling charges incurred in the transport of the Product(s) to the service location. VTech will return repaired or replaced Product under this limited warranty. Transportation, delivery or handling charges are prepaid. VTech assumes no risk for damage or loss of the Product in transit. If the Product failure is not covered by this limited warranty, or proof of purchase does not meet the terms of this limited warranty, VTech will notify you and will request that you authorize the cost of repair prior to any further repair activity. You must pay for the cost of repair and return shipping costs for the repair of Products that are not covered by this limited warranty.

What must you return with the Product to get warranty service?

1. Return the entire original package and contents including the Product to the VTech service location along with a description of the malfunction or difficulty; and
2. Include a "valid proof of purchase" (sales receipt) identifying the Product purchased (Product model) and the date of purchase or receipt; and
3. Provide your name, complete and correct mailing address, and telephone number.

Other limitations

This warranty is the complete and exclusive agreement between you and VTech. It supersedes all other written or oral communications related to this Product. VTech provides no other warranties for this Product. The warranty exclusively describes all of VTech's responsibilities regarding the Product. There are no other express warranties. No one is authorized to make modifications to this limited warranty and you should not rely on any such modification.

State/Provincial Law Rights: This warranty gives you specific legal rights, and you may also have other rights, which vary from state to state or province to province.

Limitations: Implied warranties, including those of fitness for a particular purpose and merchantability (an unwritten warranty that the Product is fit for ordinary use) are limited to one year from the date of purchase. Some states/provinces do not allow limitations on how long an implied warranty lasts, so the above limitation may not apply to you. In no event shall VTech be liable for any indirect, special, incidental, consequential, or similar damages (including, but not limited to lost profits or revenue, inability to use the Product or other associated equipment, the cost of substitute equipment, and claims by third parties) resulting from the use of this Product. Some states/provinces do not allow the exclusion or limitation of incidental or consequential damages, so the above limitation or exclusion may not apply to you.

Please retain your original sales receipt as proof of purchase.

Appendix

FCC, ACTA and IC regulations

FCC Part 15

This equipment has been tested and found to comply with the requirements for a Class B digital device under Part 15 of the Federal Communications Commission (FCC) rules. These requirements are intended to provide reasonable protection against harmful interference in a residential installation. This equipment generates, uses and can radiate radio frequency energy and, if not installed and used in accordance with the instructions, may cause harmful interference to radio communications. However, there is no guarantee that interference will not occur in a particular installation. If this equipment does cause harmful interference to radio or television reception, which can be determined by turning the equipment off and on, the user is encouraged to try to correct the interference by one or more of the following measures:

- Reorient or relocate the receiving antenna.
- Increase the separation between the equipment and receiver.
- Connect the equipment into an outlet on a circuit different from that to which the receiver is connected.
- Consult the dealer or an experienced radio/TV technician for help.

Changes or modifications to this equipment not expressly approved by the party responsible for compliance could void the user's authority to operate the equipment.

This device complies with Part 15 of the FCC rules. Operation is subject to the following two conditions: (1) this device may not cause harmful interference, and (2) this device must accept any interference received, including interference that may cause undesired operation. Privacy of communications may not be ensured when using this telephone.

To ensure safety of users, the FCC has established criteria for the amount of radio frequency energy that can be safely absorbed by a user or bystander according to the intended usage of the product. This product has been tested and found to comply with the FCC criteria. The handset may be safely held against the ear of the user.

Caution: To maintain the compliance with the FCC's RF exposure guideline, the telephone base shall be installed and used such that parts of the user's body other than the hands are maintained at a distance of approximately 20 cm (8 inches) or more.

This Class B digital apparatus complies with Canadian ICES-003.

For body worn operation, this pendant has been tested and meets the FCC RF exposure guidelines when used with the Vtech accessories supplied or designated for this product. Use of other accessories may not ensure compliance with FCC RF exposure guidelines.

Appendix

FCC, ACTA and IC regulations

FCC Part 68 and ACTA

This equipment complies with Part 68 of the FCC rules and with technical requirements adopted by the Administrative Council for Terminal Attachments (ACTA). The label on the back or bottom of this equipment contains, among other things, a product identifier in the format US:AAAEQ##TXXXX. This identifier must be provided to your telephone service provider upon request.

The plug and jack used to connect this equipment to premises wiring and the telephone network must comply with applicable Part 68 rules and technical requirements adopted by ACTA. A compliant telephone cord and modular plug is provided with this product. It is designed to be connected to a compatible modular jack that is also compliant. An RJ11 jack should normally be used for connecting to a single line and an RJ14 jack for two lines. See the installation instructions in the user's manual.

The Ringer Equivalence Number (REN) is used to determine how many devices you may connect to your telephone line and still have them ring when you are called. The REN for this product is encoded as the 6th and 7th characters following the US: in the product identifier (e.g., if ## is 03, the REN is 0.3). In most, but not all areas, the sum of all RENs should be five (5.0) or less. For more information, contact your telephone service provider.

This equipment may not be used with Party Lines. If you have specially wired alarm dialing equipment connected to your telephone line, ensure the connection of this equipment does not disable your alarm equipment. If you have questions about what will disable alarm equipment, consult your telephone service provider or a qualified installer.

If this equipment is malfunctioning, it must be unplugged from the modular jack until the problem has been corrected. Repairs to this telephone equipment can only be made by the manufacturer or its authorized agents. For repair procedures, follow the instructions outlined under the **Limited warranty**.

If this equipment is causing harm to the telephone network, the telephone service provider may temporarily discontinue your telephone service. The telephone service provider is required to notify you before interrupting service. If advance notice is not practical, you will be notified as soon as possible. You will be given the opportunity to correct the problem and the telephone service provider is required to inform you of your right to file a complaint with the FCC. Your telephone service provider may make changes in its facilities, equipment, operation, or procedures that could affect the proper functioning of this product. The telephone service provider is required to notify you if such changes are planned.

If this product is equipped with a corded or cordless handset, it is hearing aid compatible.

If this product has memory dialing locations, you may choose to store emergency telephone numbers (e.g., police, fire, medical) in these locations. If you do store or test emergency numbers, please:

Remain on the line and briefly explain the reason for the call before hanging up.

Perform such activities in off-peak hours, such as early morning or late evening.

Appendix

FCC, ACTA and IC regulations

Industry Canada

Operation is subject to the following two conditions: (1) this device may not cause harmful interference, and (2) this device must accept any interference, including interference that may cause undesired operation.

The term "IC:" before the certification/registration number only signifies that the Industry Canada technical specifications were met.

The Ringer Equivalence Number (REN) for this terminal equipment is 1.0. The REN is an indication of the maximum number of devices allowed to be connected to a telephone interface. The termination on an interface may consist of any combination of devices subject only to the requirement that the sum of the RENs of all the devices does not exceed five.

This product meets the applicable Industry Canada technical specifications.

Appendix

Technical specifications

Frequency control	Crystal controlled PLL synthesizer
Transmit frequency	Telephone base: 1921.536-1928.448 MHz Handset: 1921.536-1928.448 MHz Pendant: 1921.536-1928.448 MHz
Channels	5
Nominal effective range	Maximum power allowed by FCC and IC. Actual operating range may vary according to environmental conditions at the time of use.
Power requirements	Telephone base: 6V DC @ 400mA Handset charger: 6V AC @ 300mA Handset battery: 2.4V Ni-MH Pendant charger: 6V DC @ 400mA Pendant battery: 3.7V Li-ion
Memory	Directory: 50 memory locations; up to 30 digits and 15 characters Caller ID log: 50 memory locations; up to 24 digits and 15 characters

Index

A

- Add a handset 9
- Add a pendant 10
- Add a photo 19
- Add a reminder 45
- Announcement 47
- Answer a call 29
- Answering system
 - and voicemail 52
- Answering system operation 52–58
- Answering system settings 47–51
- Answer on/off 48
- Audio Assist® 30

B

- Battery 2, 6, 7, 61, 62

C

- Caller ID 25, 43–44
- Call intercept 54
- Call screening 48, 54
- Chain dialing 33
- Check voicemail 33
- Clear voicemail indicators 24
- Clock 22

D

- Date and time 22
- Delete a phonebook entry 40
- Delete messages 57
- Deregister all devices 11
- Dialing options 44
- Dial mode 26

E

- ECO mode 75
- Edit a phonebook entry 40
- End a call 29
- Equalizer 30

F

- Find handset/pendant 35

H

- Handset battery charging 7
- Handset battery installation 2
- Handset charger installation 3
- Handset layout 16–17
- Handset locator 35
- Happy message 27
- Home area code 26

I

- Intercom 37–38

J

- Join a call 36

K

- Key tone 25

L

- LCD language 23
- Limited warranty 79–80

Index

M

Maintenance 76
Make a call 29
Memo 57
Menu 20
Message alert tone 50, 54
Message capacity 53
Message playback 55–56
Message recording time 51
Missed call indicator 43
Mute 31

N

Number of rings 49

O

Operating range 75

P

Pendant attachment 5
Pendant battery charging 7
Pendant charger installation 4
Pendant layout 15
Phonebook 39–40
Photo speed dial 18–19, 41–42
Play messages 55–56

Q

Quiet mode 27

R

Record an announcement 47
Redial 32
Registration 9, 10
Reminder 45–46

Remote access 50, 58
Rename 24
Review reminders 46
Review the caller ID log 43
Ringer silencing 32
Ringer tone 21
Ringer volume 20

S

Save a call log entry 44
Set date and time 22
Share a call 36
Speakerphone 30
Speed dial 18–19, 41–42

T

Talking digit 23
Technical specifications 84
Telephone base installation 1
Telephone base layout 12–14
Tone dialing 32
Transfer a call 34
Troubleshooting 63–72

V

Voice Announce caller ID 22
Voice command 28, 59–60
Voicemail 23, 24, 33, 52
Volume 20, 25, 31

W

Warranty 79–80

VTECH TELECOMMUNICATIONS LTD.

A member of THE VTECH GROUP OF COMPANIES.

Distributed in the U.S.A. by VTech Communications, Inc., Beaverton, Oregon 97008.

Distributed in Canada by VTech Technologies Canada Ltd., Richmond, B.C. V6W 1L5.

VTech is the registered trademark of VTech Holdings Limited.

Copyright © 2013 for VTECH TELECOMMUNICATIONS LTD.

All rights reserved. Printed in China.

91-007294-010-100

vtech[®]